

6740001

Model 674, 676

GPL HotCup

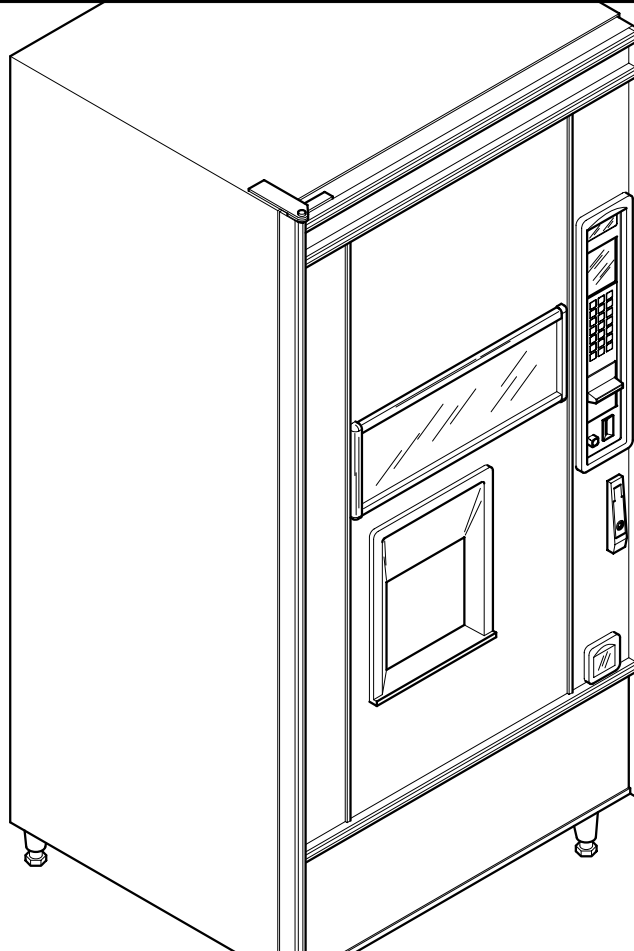

Operators' Guide



The Right Part, Right Now

CRANE

MERCHANDISING SYSTEMS™ A Crane Co. Company

CMS PARTS & SUPPORT

12955 Enterprise Way
Bridgeton, Missouri 63044-1200
(314) 298-3500 / (800) 621-7278

www.cranems.com

6740001

Terms and Conditions of Sale

LIMITED WARRANTY: Subject to the limitation specified herein, all parts included on original equipment manufactured by CRANE MERCHANDISING SYSTEMS and sold to purchaser are warranted for one year from the date of shipment of the equipment in question. This warranty applies only to the original purchaser of the Merchandiser and is null and void if the Merchandiser is sold during the period of warranty.

Defective parts will be repaired or replaced free of charge when the defective part is returned, with transportation charges prepaid by purchaser, to a destination designated by CRANE MERCHANDISING SYSTEMS.

This warranty does not include any cost of service rendered or repairs made by customer or its agents on Merchandiser, or parts, unless authorization to incur such expense has been given in writing by CRANE MERCHANDISING SYSTEMS prior to incurring such expense. This warranty does not cover labor and service charges performed by CRANE MERCHANDISING SYSTEMS service technicians.

This warranty does not apply to A) electrical components, wiring, or circuits or mechanical parts or assemblies damaged as a result of operating the Merchandiser at other than the design voltage and frequency specified on the Electrical Rating Tag, or B) in event of vandalism, fire or negligence, or C) incandescent lamps, neon lamps, fluorescent lamps, ballasts, starters or other expendable items, or D) when seal is broken on electronic boards, or E) when other manufactured components are installed in CRANE MERCHANDISING SYSTEMS Merchandisers.

Replacement parts sold by CRANE MERCHANDISING SYSTEMS as After Market shall be covered for three months from the date shown on the parts invoice. Purchaser must obtain prior RETURN AUTHORIZATION for return of all parts, following guidelines given by CRANE MERCHANDISING SYSTEMS.

New, unused parts purchased as After Market can be returned within 30 days from date of parts invoice, with prior authorization from CRANE MERCHANDISING SYSTEMS.

THIS WARRANTY IS IN LIEU OF ALL OTHER WARRANTIES EXPRESS OR IMPLIED, INCLUDING WITHOUT LIMITATION, WARRANTIES OF MERCHANTABILITY OF FITNESS FOR A PARTICULAR PURPOSE. CRANE MERCHANDISING SYSTEMS SHALL NOT BE RESPONSIBLE FOR CONSEQUENTIAL OR PUNITIVE DAMAGES. CRANE MERCHANDISING SYSTEMS neither assumes nor authorizes any person to assume for it any obligation or liability in connection with the sale of said equipment or any part thereof.

Table of Contents

Specifications.....	1
Major Parts	3
Controls and Indicators.....	7
Initial Setup.....	13
Location Preparation.....	13
Electrical Power Requirements.....	13
Check the Power Outlet.....	13
Water Requirements.....	14
Positioning the Merchandiser.....	14
Connecting Everything.....	15
Final Mechanical Preparation	16
Adjustments and Minor Maintenance.....	30
Programming The HotCup	34
Getting Around.....	34
The Service Keypad.....	34
The Selection Switch Panel	34
The Display	35
The Function Keys	35
Other Keys	36
Control Panel Switches Explained	36
Programming Procedures.....	38
Some Conventions	38
The Supervisor Mode	38
Gain Access to the Supervisor Mode	38
Enter a New Supervisor Code	39
Enter a FreeVend Code	39
Lock or Unlock Mode or Payout Keys	39
Set the Printer Baud Rate	40
Set Printer or Dex Options	40
Set UpThe Optional Printer	41
DEX/UCS Interface Operation	42
Lock or Unlock Data Clearing Access	43
Select Display Language	43
Monetary Setup.....	44
Select Coin Mechanism and Options	44
Select Bill Validator and Options	45

Monetary Setup (continued)

Initial Setup of a Nonstandard Bill Validator 46

Select Monetary Options 46

Select Card Reader and Options 47

Payout Coins 48

Set Up Winner Mode 48

Set Up the Mug Discount 49

Assign Cup Sizes to Selections 50

Hot Drink Setup 51

Set Up A Hot Drink 51

Whipper Options 52

View or Set the Hot Water Tank Temperature 53

Set Up Low Temperature Dispensing 53

Set Up Low Power Settings 54

Set the Brewer Rinse Time Interval 55

Set the Bowl Rinse Time 55

Clear Tank Errors and Fill the Tank 56

Set the Machine Type Configuration Code 56

Product Configuration 59

Collecting Dry Product Gram Throws 59

Cappuccino 62

Caffe Latte 63

Collecting Water Throws 63

Lock or Unlock Selections 66

Disable Selections in the Merchandiser 66

Rinse the Brewer 67

Fill the Tank 67

PosiVend™ 67

Turn PosiVend™ On or Off 68

Set up Optional or Mandatory PosiVend™ 68

Set Up the PosiVend™ Anti-Jackpot Timer 69

View Number of Mug Vends 69

View Cup Ring Cycles Related to PosiVend™ 69

View Times No Cup Was Detected After a Cup Ring Cycled 70

View Home Switch Usage Related to PosiVend™ 70

View PosiVend™ Last Recorded Calibration Value 70

View PosiVend™ Average Calibration Value 70

Pricing	71
Set Prices for Individual Selections	71
Set the Price For a Cup Only	71
Set One Price for the Entire Machine	72
Set One Price for All Regular Size Drinks	72
Set One Price for All Large Size Drinks	72
Time Setup	73
Set the Time	73
Set the Day of the Week	73
Set the Date and Year	73
Set Time-of-Day Inhibited Vending	74
Set Time-of-Day Discount Vending	74
Set Time-of-Day Free Vending	74
Time Interval Editing	75
Messages	76
Select a Stand-by Message	77
Select an Out-of-Service Message	77
Select a FreeVend Message	77
Edit Custom Messages	78
The End of Message Character	78
Entering Your Message	79
The Character Set.....	79
Test Vend Selections and Verify Credit Added	80
Testing	80
Test the Display	80
Test the Cup Mechanism	80
Test the Automatic Door (optional)	81
Test the Whippers	81
Test the Pump	81
Test the Brewer	82
Test Various Sensors and Switches	82
Rinse All Mixing Bowls	82
View Machine Info	83
View FreeVend Sales by Time Interval	83
View Discount Sales by Time Interval	83
View Free Vends	83
View Winners	84
View Time Data	84

View Machine Info (continued)

View Total Unpaid Sales 85

View Total Unpaid Vends 85

View Number of Test Vends 85

View Sales Data By Price 86

View Machine ID Number 86

Set FreeVend Options 86

FreeVend Keyswitch Option 87

View Non-Resettable Sales and Vend Data 88

View Data Three Different Ways 88

View Total Paid Sales 88

View Card Reader Paid Sales 89

View Total Paid Vends 89

Clear All Resettable Data 89

Clear Paid Sales Data Only 89

View Amount in Coin Box 90

View Amount in Validator 90

View Diagnostic Messages 90

Download Data to a PDCD 93

Change Machine ID Number 93

View the Water Tank Temperature 93

View the Current Software Version Number 93

View the Selection Machine Type 93

View the Selection Machine Type Configuration 94

View the Selection Configuration 94

Sanitation 95

Basics 95

Introduction 95

Cleaning and Sanitizing -- What's the Difference? 95

How Do I Sanitize? 95

A Good Place to Start -- Your Sanitation Kit 96

Sanitation Procedures..... 96

Overall Cleaning 103

Preventative Maintenance Cleaning 104

Cleaning Hot Water Tank..... 104

SPECIFICATIONS COMMON TO ALL MACHINES

DIMENSIONS	72" (183 cm) high 32" (81 cm) wide 28.5" (72 cm) deep
WEIGHT	475 lbs (215.5 kg)
WATER REQUIREMENTS	Minimum: 20 psi (137.8 kPa) Maximum: 80 psi (551.2 kPa)
AMBIENT TEMPERATURE	Minimum: 41° F (5° C) Maximum: 90° F (32° C)
OPERATING ENVIRONMENT	For indoor use only
CUP CAPACITIES (APPROXIMATE)	5 oz cups - 965 7 oz cups (squat) - 805 8.25 oz cups - 735 9 oz cups (squat) - 770 10 oz cups - 690 12 oz cups - 660
CANISTER CAPACITIES (APPROXIMATE)	Fresh brew coffee - 13 lbs (Model 674 only) Freeze dry coffee - 2 lbs Fresh brew decaf - 9 lbs (Model 674 only) Freeze dry decaf - 2 lbs Tea (freeze dry) 1.5 lbs Chocolate - 10 lbs Soup (or sugar substitute) - 6.7 lbs (4 lbs) Sugar - 11 lbs Lightener - 4.5 lbs
PRODUCT OPTIONS	
Model 674 Fresh Brew	Standard Configuration: Fresh brew coffee (pre-ground) Fresh brew OR freeze dry decaf Freeze dry tea Espresso, cappuccino, hot chocolate, and "cup only" selections Optional Configurations: Hot water selection Soup selection OR Sugar substitute condiment
Model 676 Freeze Dried	Standard Configuration: Freeze dry coffee Freeze dry decaf Freeze dry tea Espresso, cappuccino, hot chocolate, and "cup only" selections Optional Configurations: Hot water selection Soup selection OR Sugar substitute condiment

SPECIFICATIONS COMMON TO ALL MACHINES (CONTINUED)

OPTIONS	Automatic delivery door Base grille kit (1 sided) Base grille kit (3 sided) Coin box lock Data printer kit Debit card reader Door striping kit Everpure water filter kit Cuno water filter kit Hydro-Life water filter kit Flex Ace door lock and key Van door lock and key Free vend keyswitch Snap-on ingredient canister extension sleeves (4" tall) Sugar substitute kit Ingredient rinse tray Cup/mug electronic sensor (cup hold switch kit) PosiVend™ Hot water selection kit Filter paper kit (2400 vends per roll) for brewer (Model 674 only) Choice of "Textured white" or "Textured gray" paint for cabinet door
----------------	--

SPECIFICATIONS UNIQUE TO 115 VOLT MACHINES

ELECTRICAL	115 Volts AC 60 Hertz 12 Amps Single phase
-------------------	---

OPTIONS AND ACCESSORIES

COIN MECHANISM	CMS	MEI	CONLUX	COINCO
	NRI A66	TRC6512	CCM5G-1	USG-G7xx*
	NRI G46	CASHFLOW 7512i		VTX100 VTX101
				* denotes tube config.
BILL VALIDATORS	CMS	MEI	CONLUX	COINCO
	SMV2 4017	VN2502-U5M	NBM-300	MAG 52R
	SMV2 4117	VN2502		MC2600
	MB-2017 (Recycler)	VN2562		BP2-CRX BP4SX

SPECIFICATIONS UNIQUE TO 220 - 240 VOLT MACHINES

ELECTRICAL	220 - 240 Volts AC 50 Hertz 10 Amps 2 kW Single phase
-------------------	---

OPTIONS AND ACCESSORIES

COIN MECHANISM	Executive coin mechanism interface
-----------------------	------------------------------------

Major Parts

The diagrams on the following pages will acquaint you with the major parts of the HotCup merchandiser. For more detailed information, please consult your PARTS MANUAL. If you do not have a PARTS MANUAL, contact you local GPL distributor.

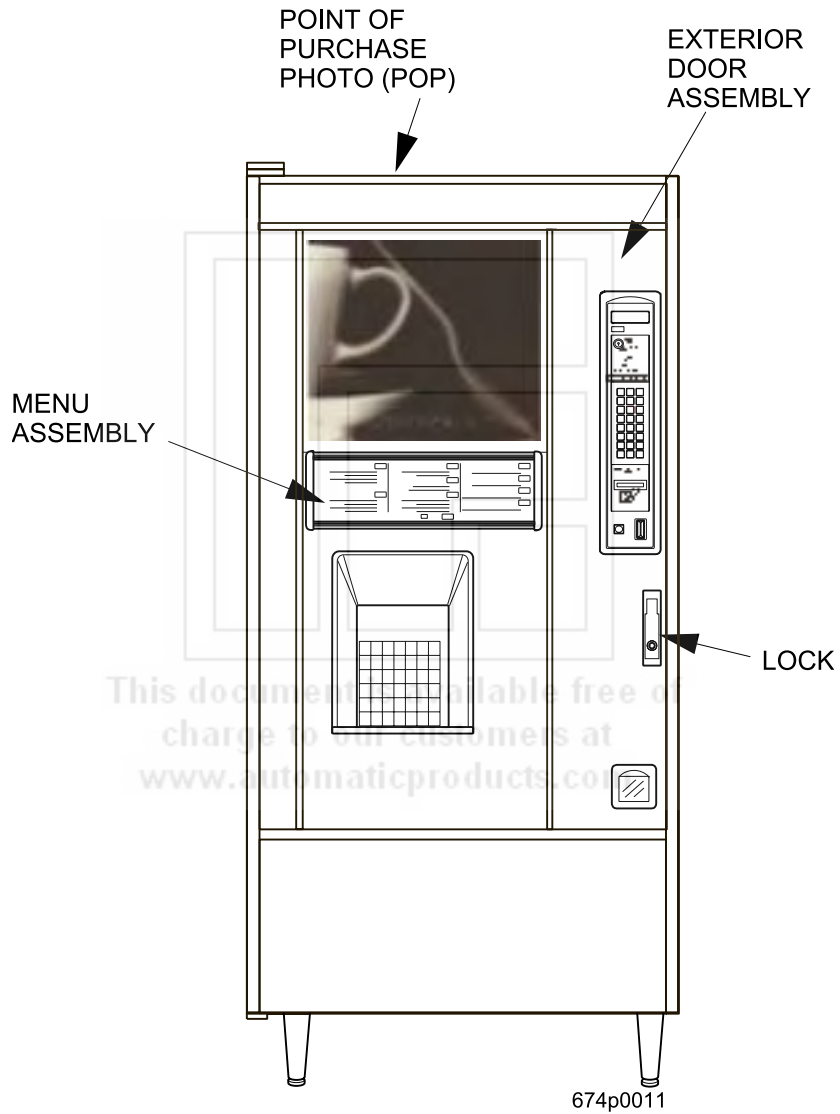

FRONT OF MERCHANDISER

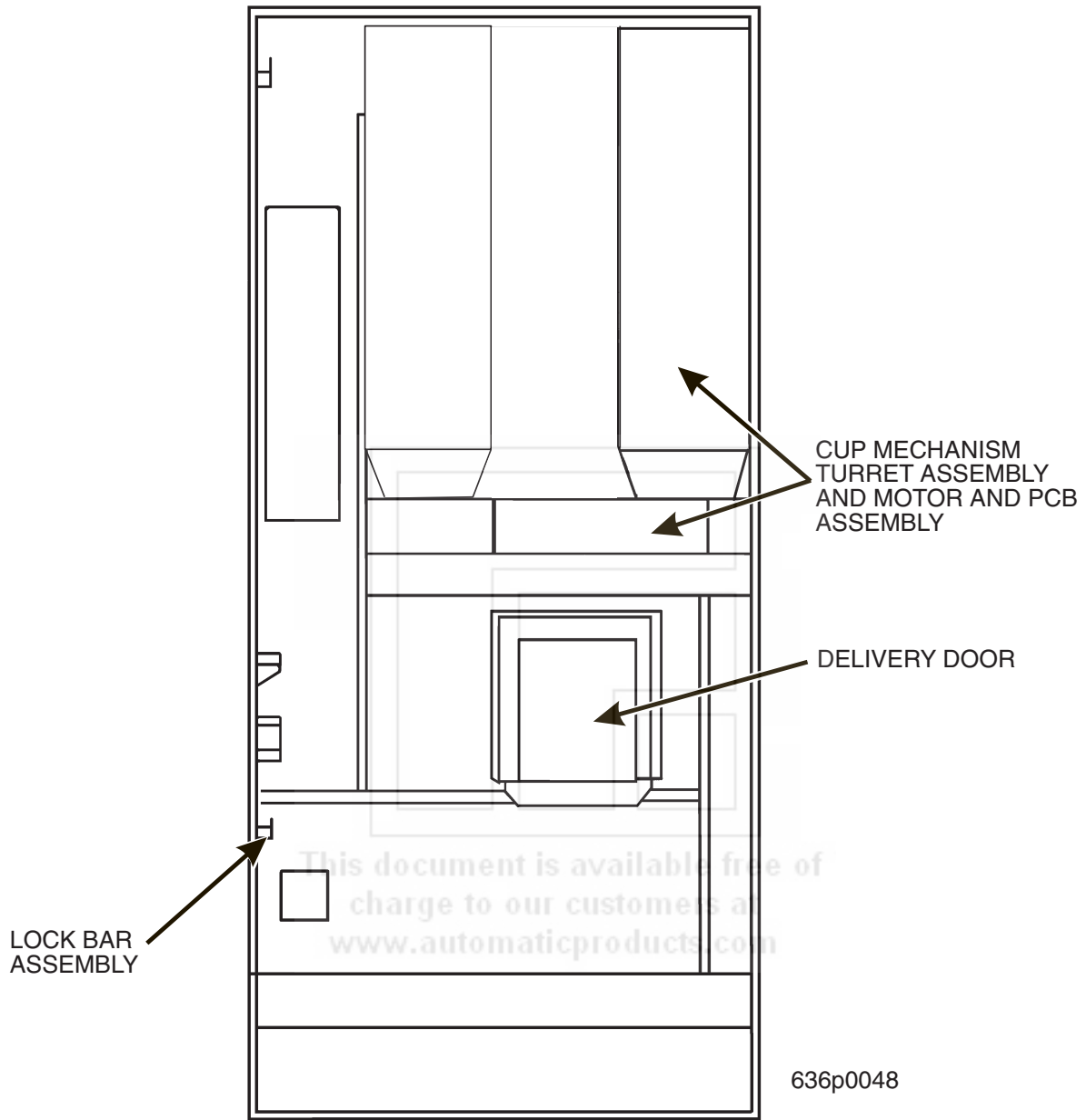

FRONT VIEW OF MERCHANDISER

INTERIOR VIEW OF MERCHANDISER DOOR

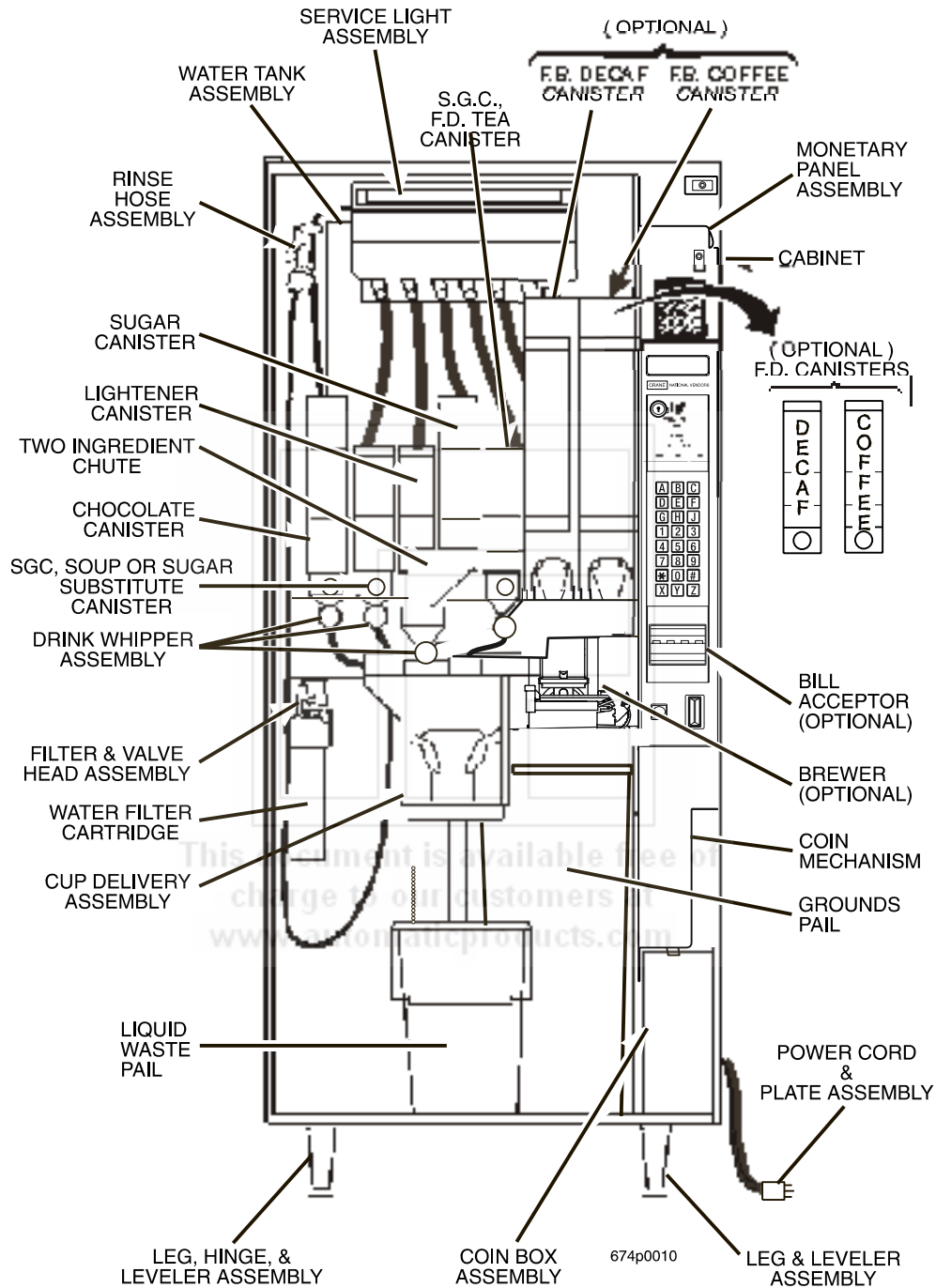

MERCHANDISER CABINET INTERIOR (FIGURE 1 OF 2)

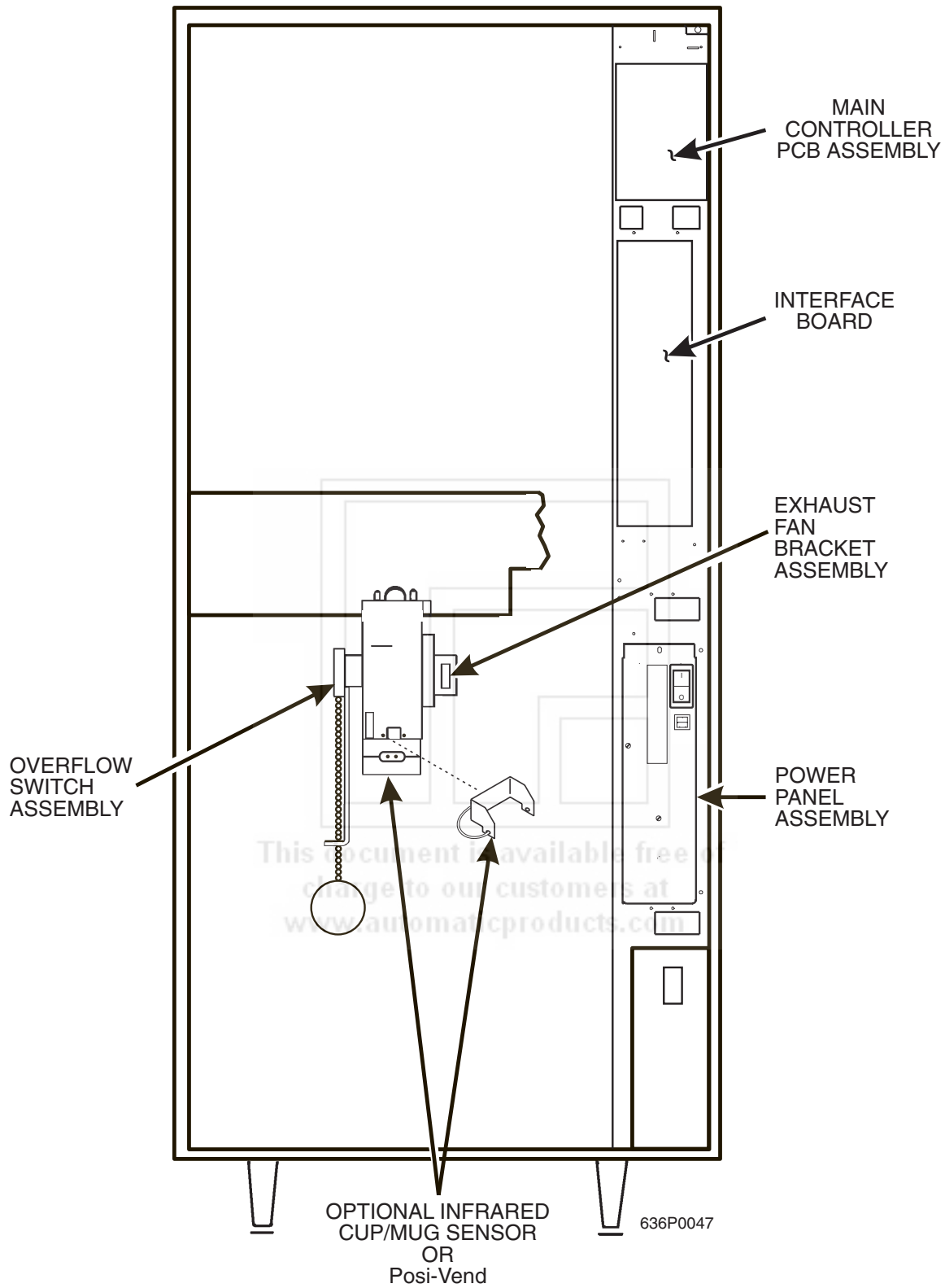

MERCHANDISER CABINET INTERIOR (FIGURE 2 OF 2)

Controls and Indicators

Power Panel. You may have one of three power panels, depending upon where you live. The controls are fundamentally the same, however.

Circuit Breakers. Circuit breakers protect the merchandiser against failures in the power supply or any of the electrical components. If a circuit breaker trips and cannot be reset, consult your troubleshooting manual.

Back Side of U.S./ Canada Power Control Panel. The circuit board mounted on the rear of the U.S. and Canadian power control panel is a dc power supply for the coin mechanism. A fuse protects the board circuitry in the event of a coin mechanism solenoid failure. If the coin mechanism is not working, check this fuse. If the fuse is blown, a bad coin mechanism solenoid could be at fault.

Main Power Switch. This is the main ON/OFF switch for the merchandiser.

WARNING
To protect against electrical shocks and possible damage to the machine, turn this switch OFF when performing any maintenance on the merchandiser.

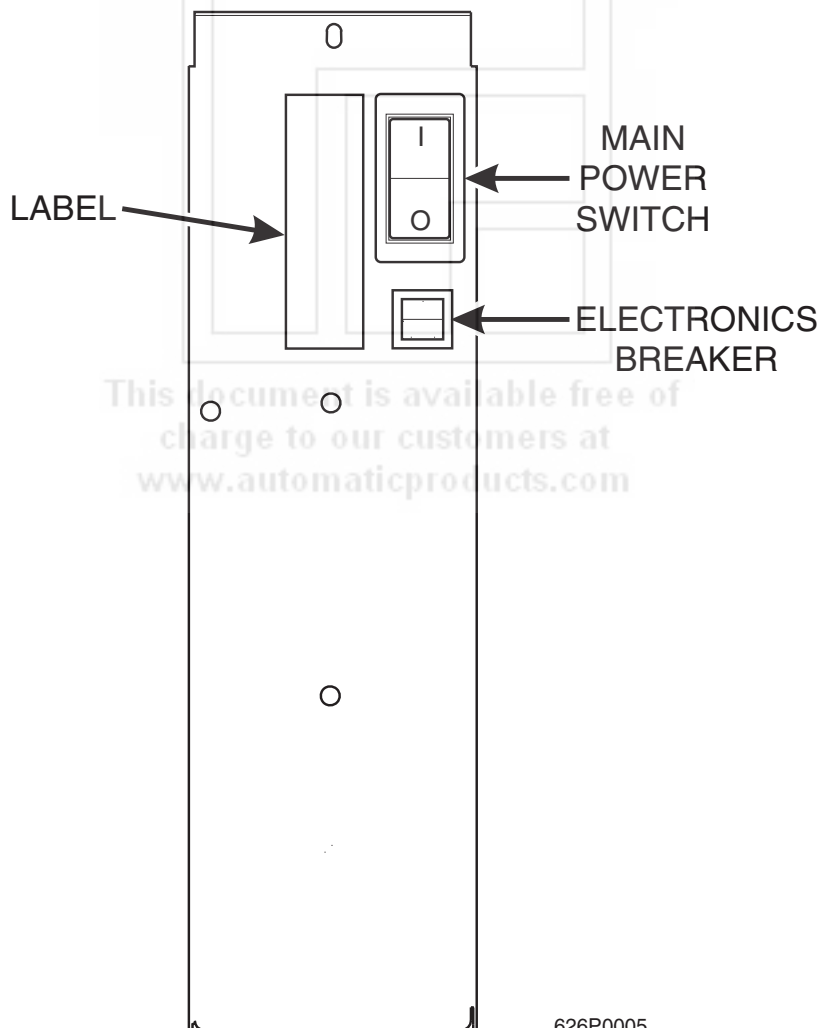

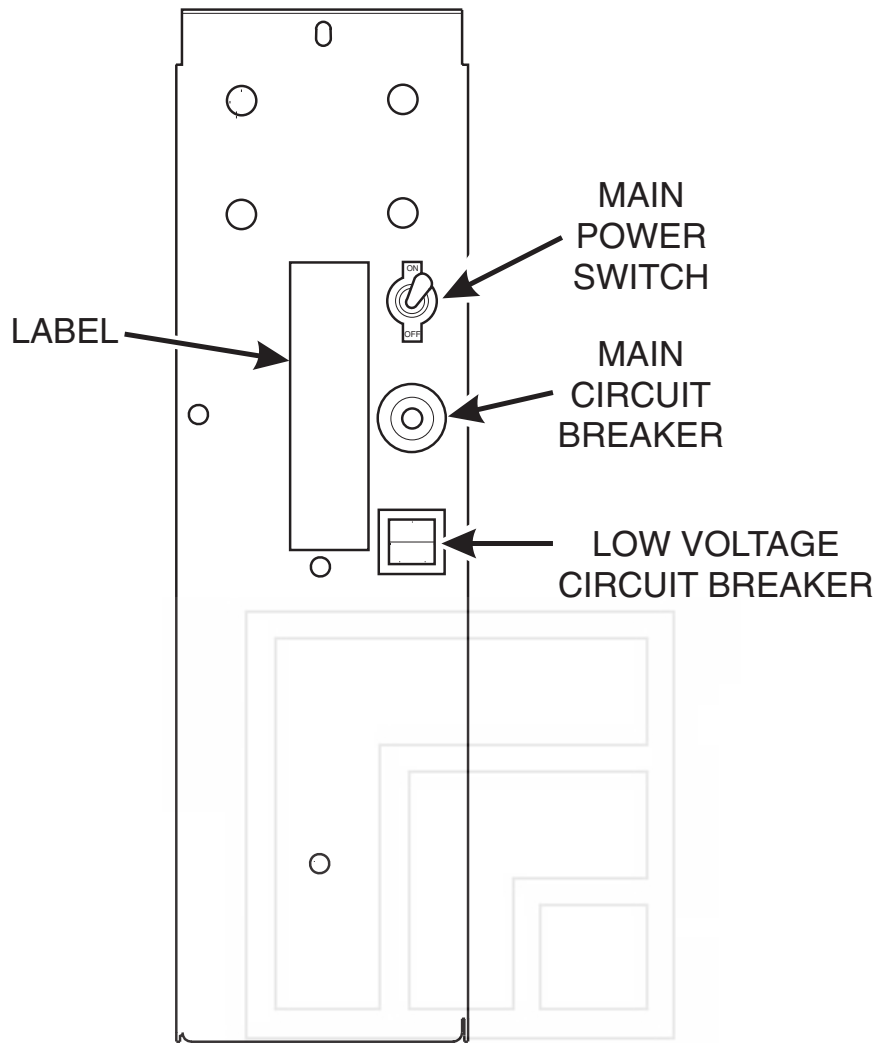

POWER CONTROL PANEL FRONT SIDE (U.S./CANADA)

This document is available free of charge to our customers at www.automaticproducts.com

POWER CONTROL BACK SIDE PANEL (U.S./CANADA))

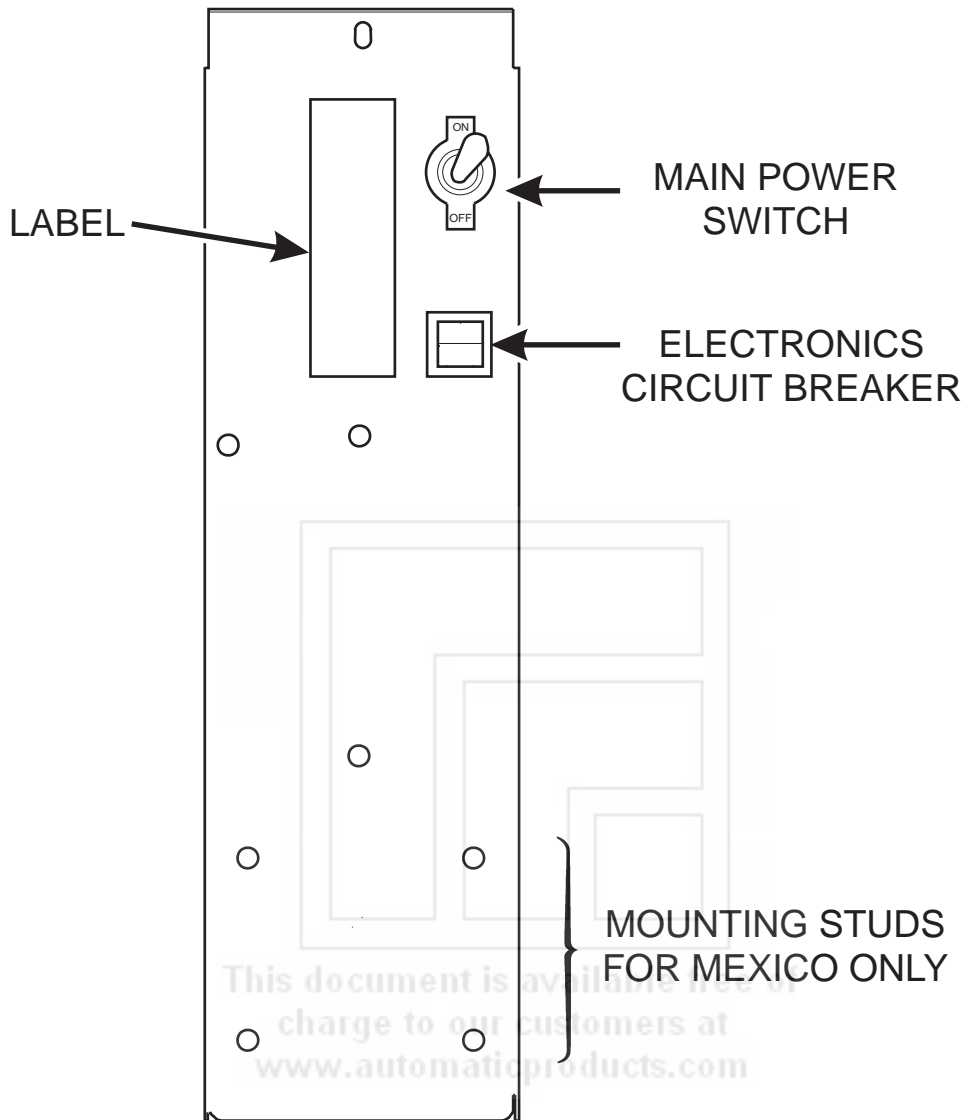

**POWER CONTROL PANEL
(U.K./ MEXICO)**

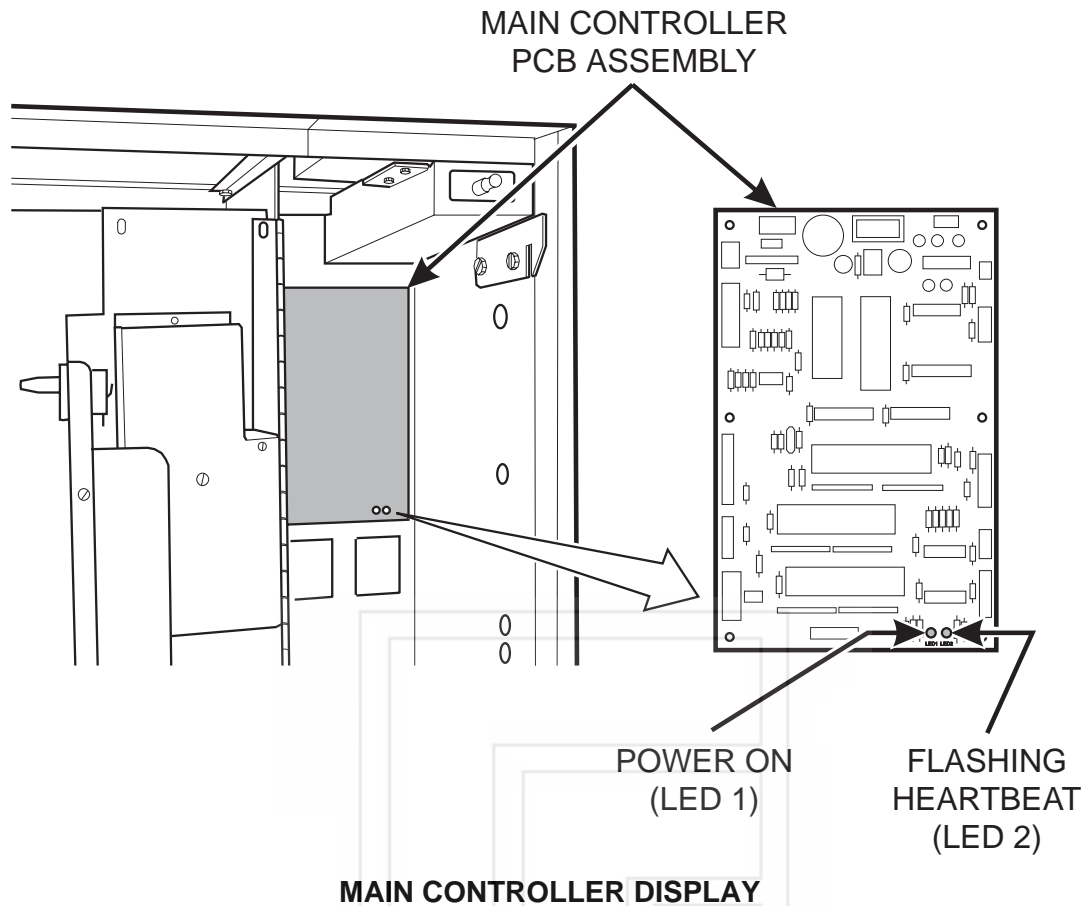

Main Controller PCB Display. This display consists of two light emitting diodes (LED) mounted on the controller PCB.

POWER ON (LED 1)

When lit, this red LED indicates electrical power is applied to the controller PCB.

HEARTBEAT (LED 2)

When flashing, this red LED indicates that the controller PCB is active, and the software is operating.

NORMAL CONDITIONS:

When the merchandiser is operating normally, you should see a steady red POWER ON indicator. The red HEARTBEAT indicator should be flashing with a balanced on/off pattern (on for the same length of time that it is off).

ERROR CONDITIONS:

If an error is present, the red HEARTBEAT indicator will flash with an unbalanced on/off pattern (on longer than it is off). The error(s) can be viewed under the DIAGNOSTICS mode.

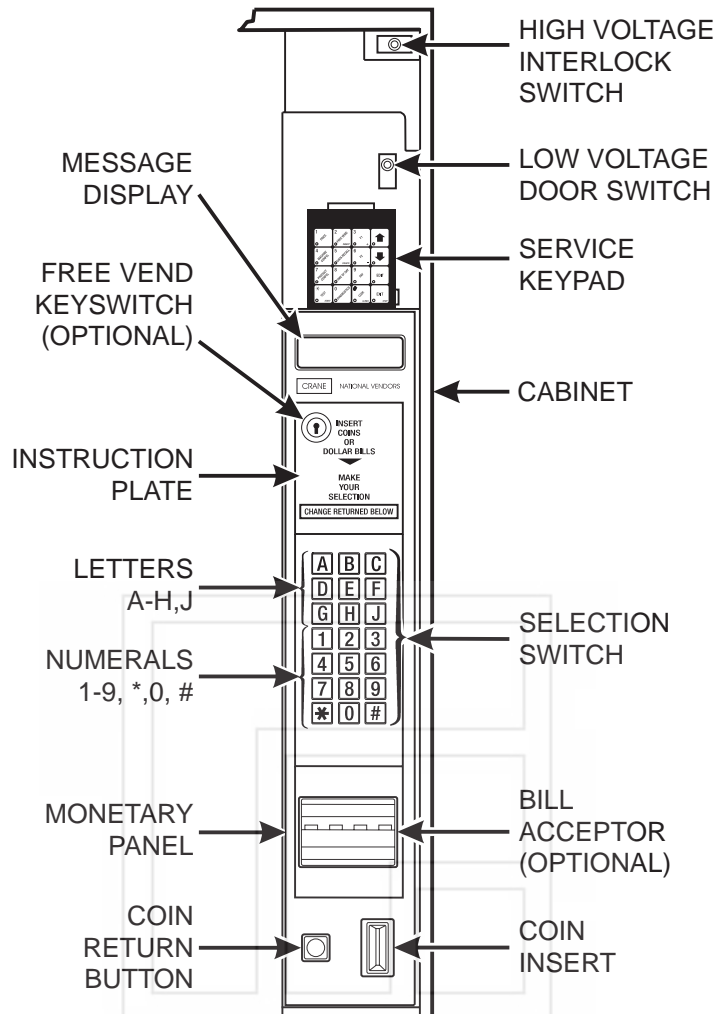

This document is available free of charge to our customers at www.automaticproducts.com

MONETARY PANEL

High Voltage Interlock Switch (U.S./ Canada). When the cabinet door is open, this switch turns off the optional fan and bean light (if equipped), and turns on the service light.

High Voltage Interlock Switch (International). When the cabinet door is open, this switch turns off all high voltage to the cabinet. Pulling the switch out restores high voltage for maintenance purposes.

Low Voltage Door Switch. Informs the controller software of the main door open or closed status.

Message Display. This is how the merchandiser communicates with the outside world. Customers can see messages about how much money they have put into the merchandiser. The message display also tells customers when a selection is sold out and when vending is free, inhibited, or discounted. The message display shows you what you are doing when you program the merchandiser, and can show you what is wrong if there is a failure.

Free Vend Keyswitch. This allows someone (other than maintenance people) to set the merchandiser to free vend without opening the door.

Selection Switch Panel. The customer uses these switches to make selections. Also, maintenance people may use this switch panel during programming and other support modes.

Coin Return Button. Pressing this button returns any coins that have been paid into the merchandiser prior to a vend.

Bill Acceptor (Optional). Accepts bills in various denominations, depending upon the type of bill valedictory, and how the machine is configured.

Service Keypad. The service keypad is located at the top of the monetary panel. It gives service personnel the means to program, retrieve data from, and view diagnostic information about, the merchandiser.

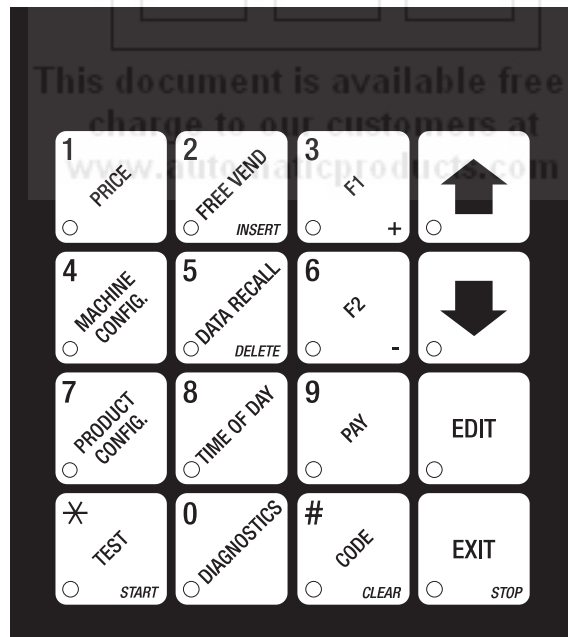

SERVICE KEYPAD

I. Location Preparation

After your machine is unpacked and placed near its permanent location, you need to make sure you have the proper electrical and water service.

ELECTRICAL POWER REQUIREMENTS

This merchandiser needs electrical power as shown in the following table.

NOTE:

Each merchandiser should have its own electrical circuit.

POWER REQUIREMENTS

Country	Volts	Frequency (Hz)	Current (Amps)
Canada	115	60	15
France	230	50	10
Germany	230	50	10
United Kingdom	230	50	10
United States	115	60	15

CHECK THE POWER OUTLET

This merchandiser is supplied with a service cord for the country of use and is terminated in a grounding type plug. The wall receptacle used for this merchandiser must be properly polarized, grounded, and of the correct voltage. Operating the merchandiser from a source of low voltage will VOID YOUR WARRANTY. Each merchandiser should have its own electrical circuit and that circuit should be protected with a circuit breaker or fuse conforming to local regulations.

Voltage Check - Place the leads of a voltmeter across the LINE (LIVE) and NEUTRAL terminals of the wall receptacle. The voltmeter should indicate 110-130 volts ac for 120 volt, 60 Hz locations, or 220-240 volts ac for 230 volt, 50 Hz locations.

Polarity Check - Place the leads of a voltmeter across the LINE (LIVE) and GROUND terminals of the wall receptacle. The voltmeter should indicate 110-130 volts ac for 120 volt, 60 Hz locations, or 220-240 volts ac for 230 volt, 50 Hz locations.

Noise Potential Check - Place the leads of a voltmeter across the NEUTRAL and GROUND terminals of the wall receptacle. The voltmeter should indicate 0 volts ac. A measurement greater than 1.5-2.0 volts ac could result in problems for the merchandiser's electronic circuitry caused by electrical noise.

Any deviation from these requirements could result in unreliable performance from your merchandiser.

WATER REQUIREMENTS

The best type of water for coffee brewing is normal hard (tap) water. If your location has chemically softened water, you should do one of the following things:

- Have a non-softened supply line run to the merchandiser
- Contact your local water filter supplier for information and suggestions

Well water can also be used in the HotCup Machine. However, you should have it checked for levels of carbonates and alkalies. Contact your water filter supplier if these values are relatively high.

What is the Water Pressure at Your Location?

- **It should be no less than:** 20 psi (69.0 KPa) at 1/2 gallon/minute
- **And no more than:** 80 psi (522.0 KPa) at 1/2 gallon/minute

If you're not sure about the pressure and flow rate, check with your water company.

What to do With the Water Supply Line:

- Locate the supply line at the rear of your merchandiser.
- Equip the line with a shut-off valve.

Flush the water supply line before connecting it to the merchandiser. A minimum of five gallons is usually required before connecting the merchandiser to the supply line. **DO NOT** flush the merchandiser water system. If you do, you might introduce water line contaminants into the merchandiser.

II. Positioning the Merchandiser

You can position this merchandiser anywhere in a bank of machines. It can even be placed on the end flush against a side wall. Be sure you leave enough room in front of the merchandiser for the door to move freely.

**BE SURE THE REAR OF THE MERCHANDISER IS AT LEAST 6"
AWAY FROM THE WALL. THIS WILL ALLOW WARM, MOIST AIR
TO BE VENTED OUT OF THE MACHINE'S INTERIOR.**

**WARNING:
THIS MACHINE IS ONLY RATED FOR INSTALLATION IN AN
INDOOR LOCATION.**

III. Connecting Everything

1. Connect the Merchandiser to the Water Supply:

- a. You will need the following:
 - A coil of copper tubing with outside diameter of 3/8 inch (9.5 mm) or greater. The appropriate plastic tubing may be substituted. The tubing must be long enough to reach from the water source to your machine with enough left over to form a loop about 2 feet (60 cm) in diameter. This will allow you to move the machine without straining the water line.
 - A 3/8 inch (9.5 mm) flare fitting.
- b. Connect the merchandiser to your water supply.

2. Connect the Merchandiser to the Electrical Power Supply:

Power inside the merchandiser is controlled by the main power switch, located on the power panel.

- a. Make sure the main power switch is OFF.
- b. Connect the merchandiser's power cord to your wall outlet.

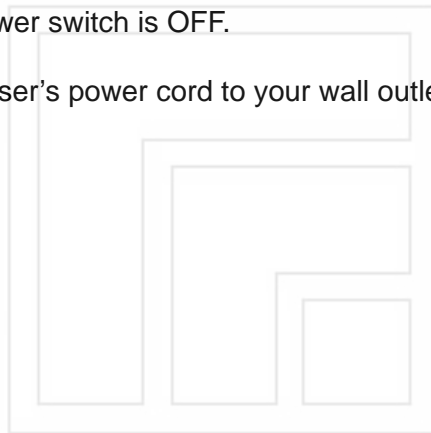

This document is available free of charge to our customers at www.automaticproducts.com

IV. Final Mechanical Preparation

1. Level the Merchandiser:

- Place a spirit level on the top front edge of the cabinet with the door fully closed. Adjust the front legs only until the cabinet is reasonably level.
- Hold the door open about 4 inches.

WARNING:

HAVE AN ASSISTANT HOLD THE MERCHANDISER WHILE YOU ADJUST THE LEG LEVELERS.

- Adjust the back legs so that the back leg leveler on the hinge side is off the floor just enough so a piece of paper can slide under it with only a bit of resistance.
- For proper weight distribution on all four legs, raise the back leg on the hinge side by unscrewing the leveler $1\frac{1}{2}$ turns.

NOTE

You may need to use pliers or channel locks to loosen the leg levelers.

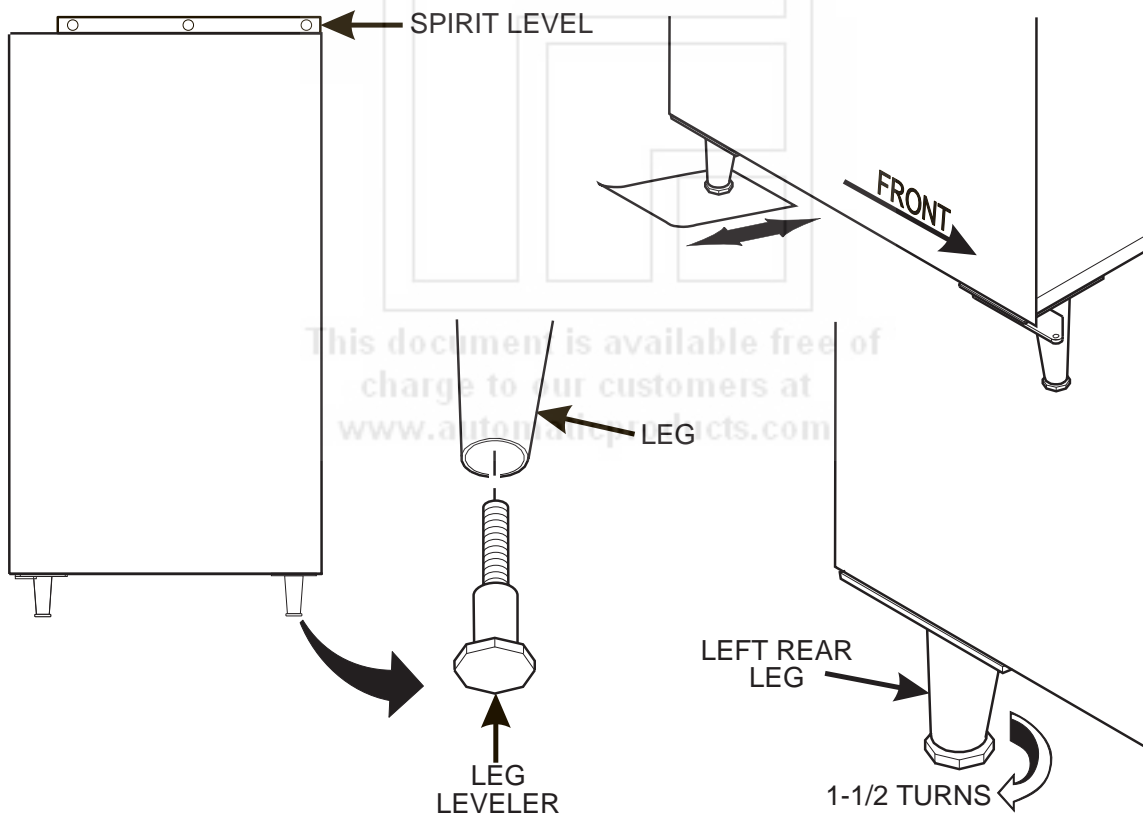

2. Mount the Base Plate:**WARNING**

DO NOT MOVE THE CABINET WHILE HEX HEAD SCREWS AND/OR CARRIAGE BOLTS ARE LOOSENED. THE CABINET COULD BECOME UNSTABLE AND LIKELY TO TIP AND CAUSE INJURY.

- a. Remove the pail(s) from the inside of the merchandiser.
- b. Remove the floor liner from the inside of the merchandiser.
- c. Remove the two caps as shown.
- d. Loosen the left leg assembly carriage bolts and nuts to allow mounting a base plate bracket.
- e. Secure one of the base plate brackets to the leg assembly using the two carriage bolts. Tighten the carriage bolts and nuts.
- f. Loosen the right leg assembly hex head screws to allow mounting the other base plate bracket.
- g. Secure the other base plate bracket to the right leg assembly using the two hex head screws. Tighten the hex head screws.
- h. Insert the short arms of the slides into the hinged tabs of the base plate. Position the slide so the notch near the short arm is on the bottom side.
- i. Insert the long arms of the slides into the base plate brackets.
- j. Insert and secure a cotter pin through the hole in the back of each of the slides.
- k. Push the base plate toward the merchandiser cabinet. The front tabs of the base plate brackets should seat in the notches in the long arms of the slides.
- l. Replace the caps, liner, and pail(s) removed previously.

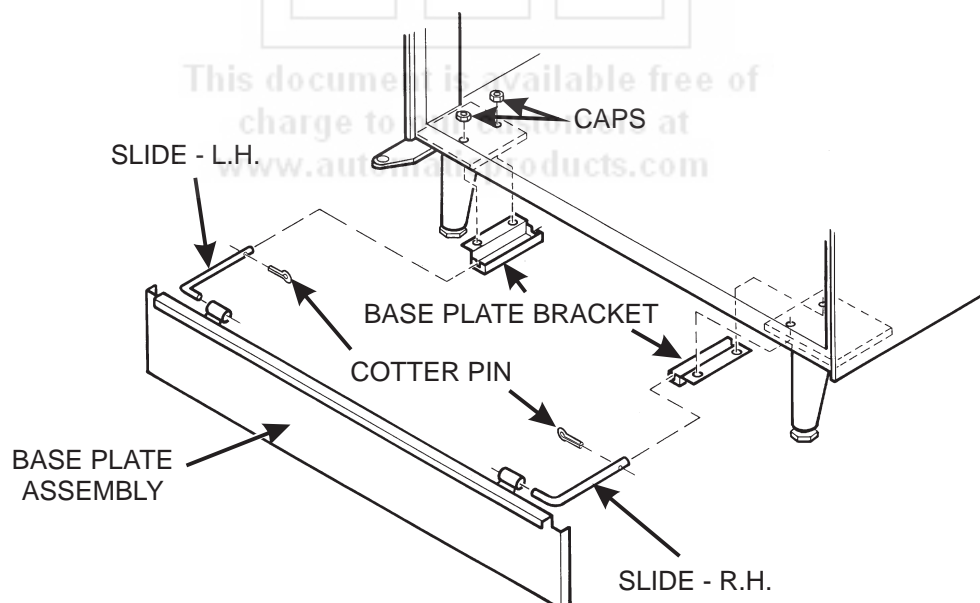

3. Install the Water Filter Cartridge:

IF YOUR MERCHANTISER HAS THE WATER FILTER OPTION, IT CANNOT BE OPERATED WITHOUT A PROPERLY INSTALLED WATER FILTER CARTRIDGE. If you do not have the water filter option, continue with "Fill the Tank".

CUNO BRAND...

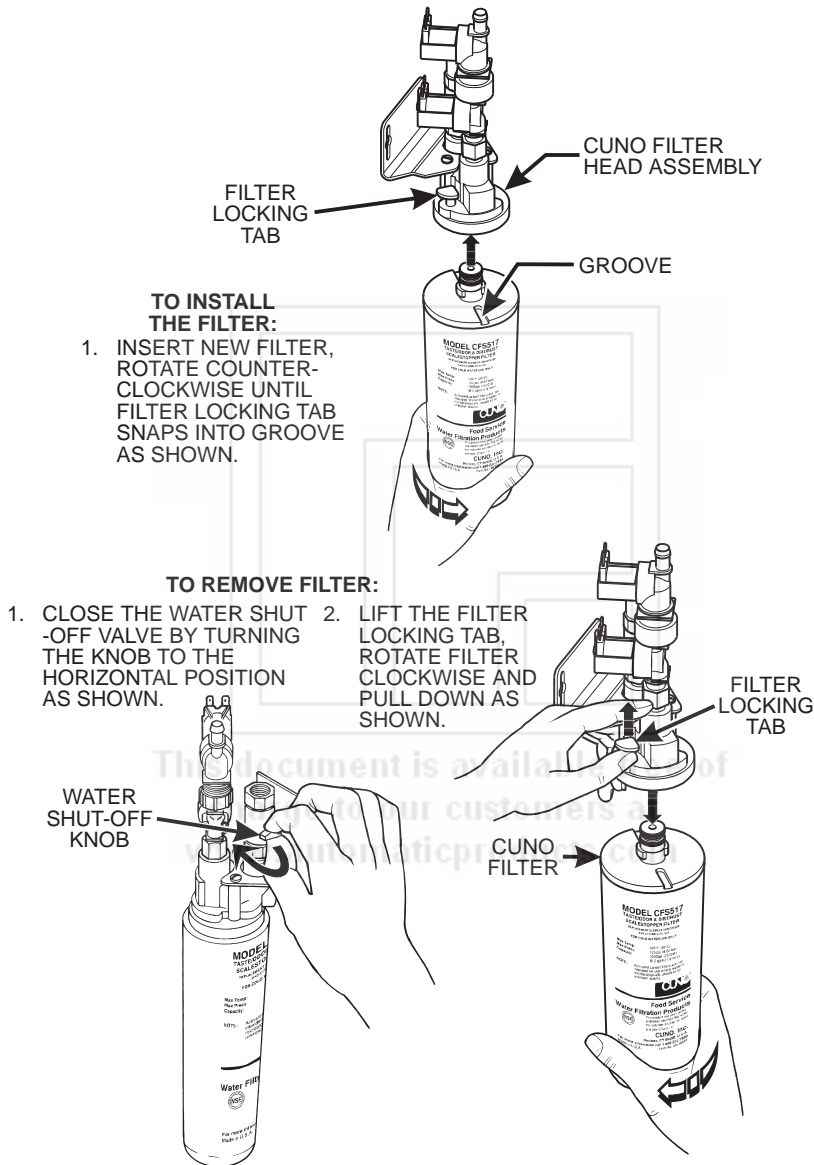

Note:

Check the water filter installation record. There is a place to write the vend number on the cartridge. The cartridge is effective for a maximum of 64,000 7 oz. vends, 56,000 8 oz. vends, 50,000 9 oz. vends, or 37,000 12 oz. vends. Local conditions may require more frequent replacement.

EVERPURE BRAND...

NOTE

Check the water filter installation record. There is a place to write the vend number on the cartridge. The cartridge is effective for a maximum of 26,000 7 oz. vends, 22,000 8 oz. vends, 20,000 9 oz. vends, or 15,000 12 oz. vends. Local conditions may require more frequent replacement.

- GPL recommends that you do the following procedure the first time you fill the tank in your HotCup merchandiser:
- Remove the small inner "O" ring from the filter cartridge.
- Install the filter cartridge.
- Turn on the water at its source, and perform the tank filling procedure.
- Turn off the water at its source, remove the filter cartridge, and replace the "O" ring.
- Install the filter cartridge.

TO INSTALL FILTER:

- ALIGN RAISED RIB ON FILTER CARTRIDGE WITH MATING SLOT IN HEAD ASSEMBLY.
- FIRMLY INSERT FILTER CARTRIDGE INTO HEAD ASSEMBLY AND ROTATE COUNTER-CLOCKWISE 1/4 TURN TO THE STOP.
- OPEN THE WATER SHUT-OFF VALVE BY PUSHING THE HANDLE TO THE HORIZONTAL POSITION AS SHOWN BELOW.

TO REMOVE FILTER:

- CLOSE THE WATER SHUT-OFF VALVE BY LIFTING THE HANDLE TO THE VERTICAL POSITION AS SHOWN BELOW.
- ROTATE THE FILTER CLOCKWISE AND PULL DOWN AS SHOWN.

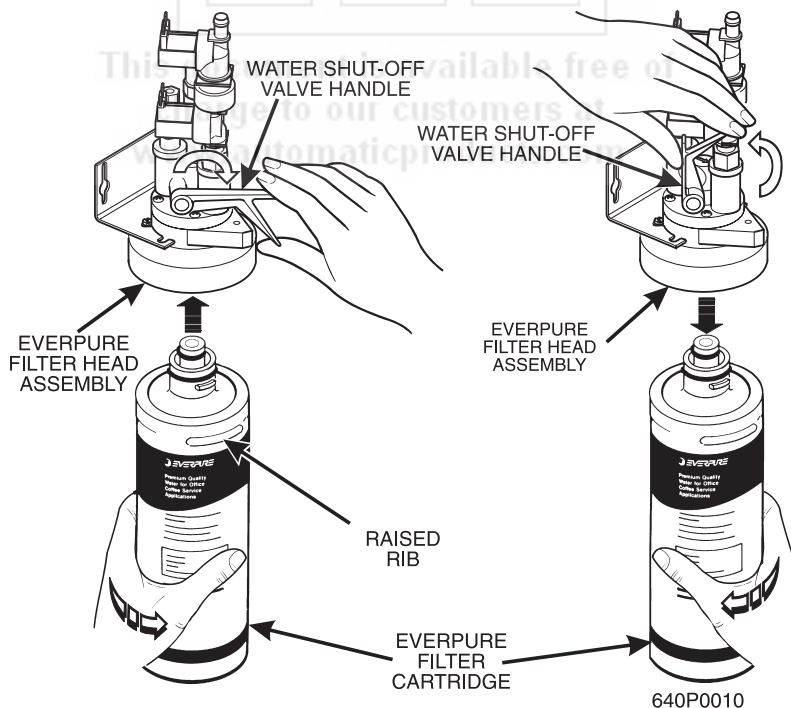

HYDROLIFE BRAND

INSTALLATION:

- Place the filter inside the canister. Be sure the o-ring is seated in the canister just below the threads.
- Screw the canister and filter assembly onto the filter head until it comes to a stop.
- Open the water valve on the inlet line by rotating the handle to the vertical position as shown.

REMOVAL:

- Close the valve on the inlet line by rotating the handle into the horizontal position as shown.
- Relieve water pressure by performing two or three water throws (See "Programming The HotCup" on page 34).
- Unscrew the filter and canister assembly from the filter head. Remove the filter from the canister.

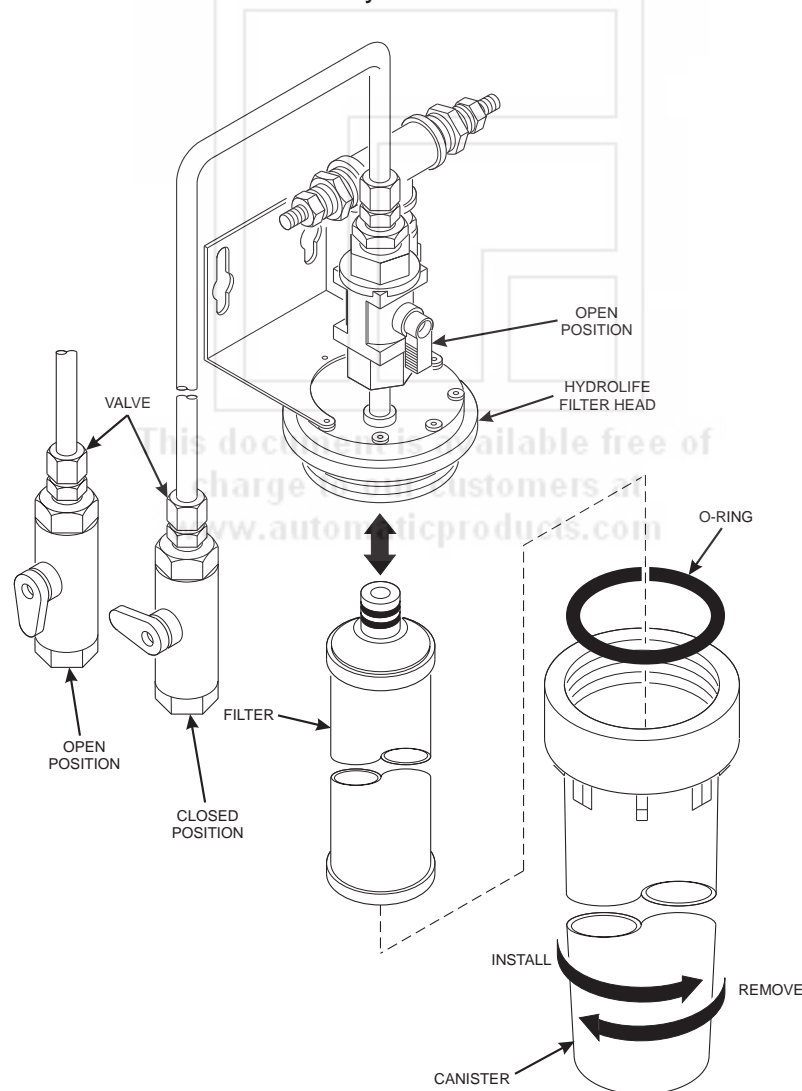

4. Load the Optional Filter Paper:

- a. Turn the fastener $\frac{1}{4}$ turn counterclockwise and remove the filter paper cover.
- b. Insert filter paper in the filter paper housing as shown.
- c. Feed the paper out of the housing as shown by the arrows molded into the back wall of the filter paper housing

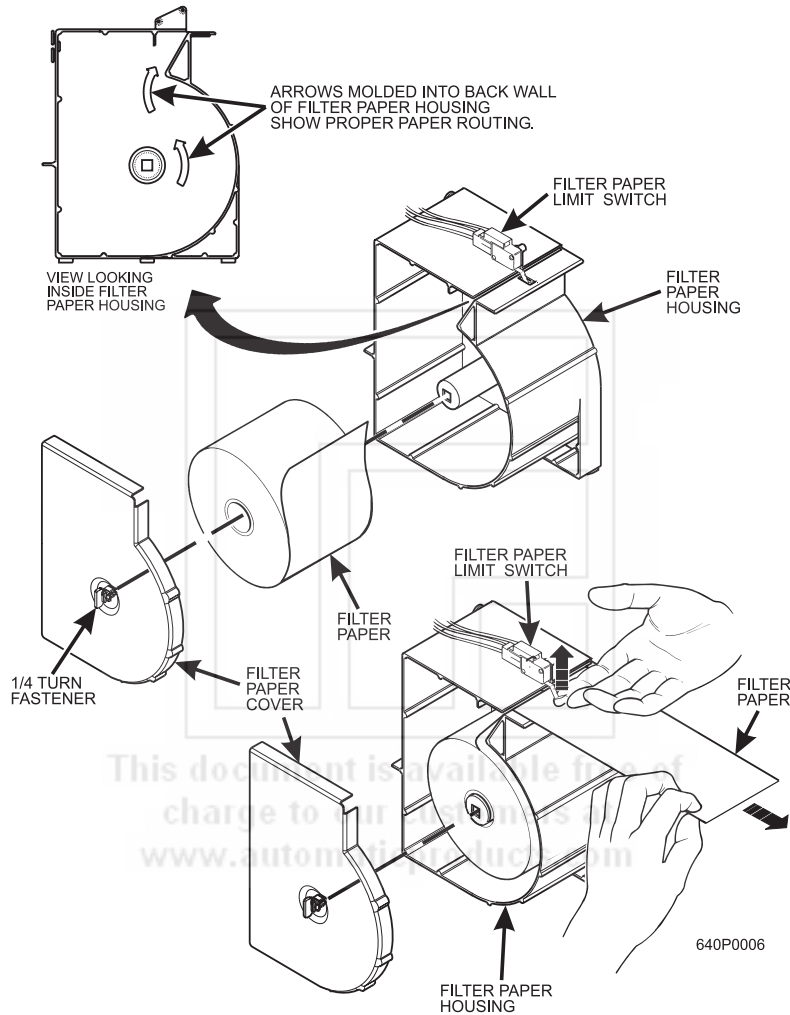

- d. Lift up the limit switch and feed the paper past it as shown. Release the limit switch.
- e. Replace the cover.
- f. Refer to routing label on filter paper cover. Feed paper under paper guide shaft and over rounded edge of stainless steel brackets as shown.
- g. Lift and rotate the idler roller assembly up.
- h. Route the paper under the brewer cylinder and the idler rollers.
- i. Release the idler roller assembly, capturing the filter paper.

- j. Route the paper into the grounds bucket

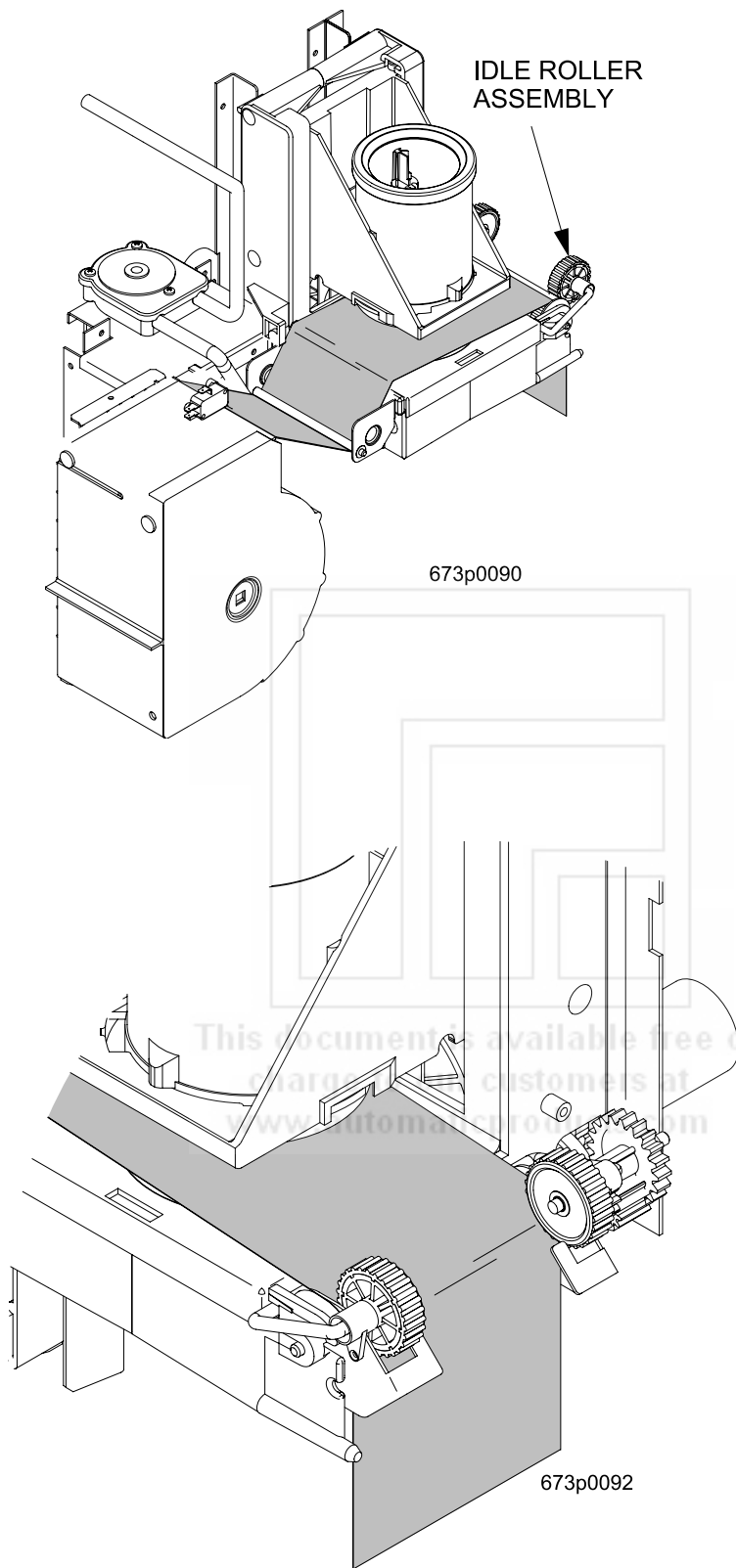

- k. Place the main power switch in the ON position.

- I. Test the brewer to be sure the paper feeds properly: On the service keypad, press



then press  until the display shows BREW TEST.

- i. Press  to test each brewer position:

WARNING

**Keep away from the brewer mechanism while it is operating.
Coming into contact with moving parts could injure you.**

BREW 'R CLMPD The brewer is in the clamp position.

BREW 'R HOME The brewer is in the open position.

- ii. Make sure the filter paper feeds properly without jamming.

5. Install the Optional Coin Box Lock

- Install the lock cylinder, washer, and nut in the order shown.
- Tighten the nut.
- Install the lock bar as shown, and secure with the screw.

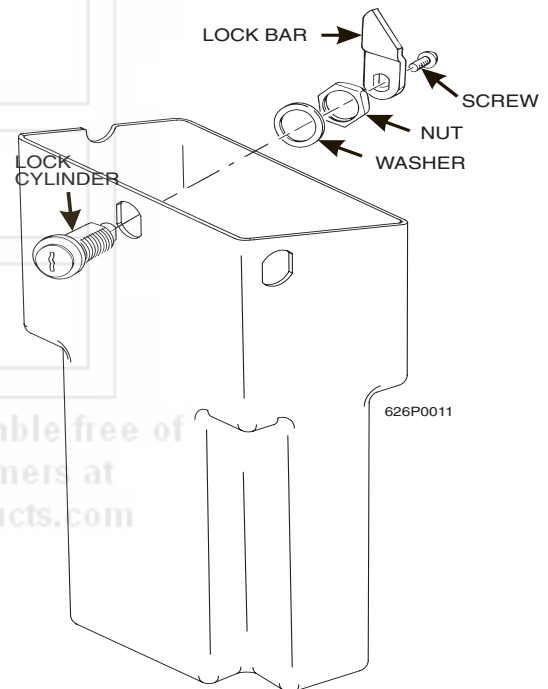

6. Set Up and Load the Coin Mechanism

Standard Coin Mechanism

Setting the Quarter Switch. If your coin mechanism is not a MARS TRC 6000, skip this procedure and begin **LOADING THE COIN MECHANISM**.

- Flip down the front of the coin mechanism as shown, and set the quarter switch.

Load the Coin Mechanism.

- Open the cabinet door and the monetary door.
- Insert coins into their respective tubes until each tube has been filled.
- Inspect the tubes for shingled coins and correct if necessary.

MDB Coin Mechanism

Install the coin mechanism as follows:

WARNING

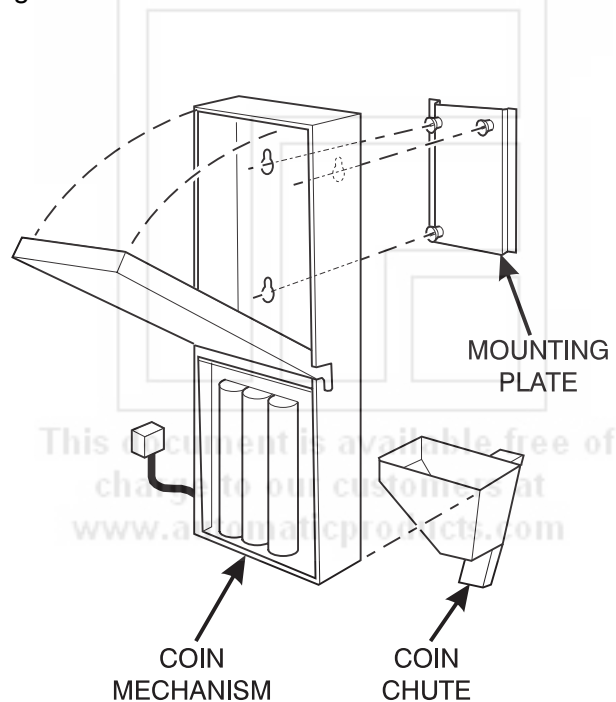

Make sure the main power switch is turned OFF before you work on the merchandiser. Failure to do so could result in death or injury.

- a. Turn OFF the main power switch. Refer to the instructions provided with the coin mechanism and remove the coin validator assembly.
- b. Loosen the coin mechanism mounting screws on the merchandiser so they stand off about 1/8" (0.3 cm).
- c. Position the coin mechanism so the three keyed holes fit over the mounting screws. Pull down on the coin mechanism to seat the screws in the keyways.
- d. Tighten the mounting screws and reinstall the coin validator assembly.



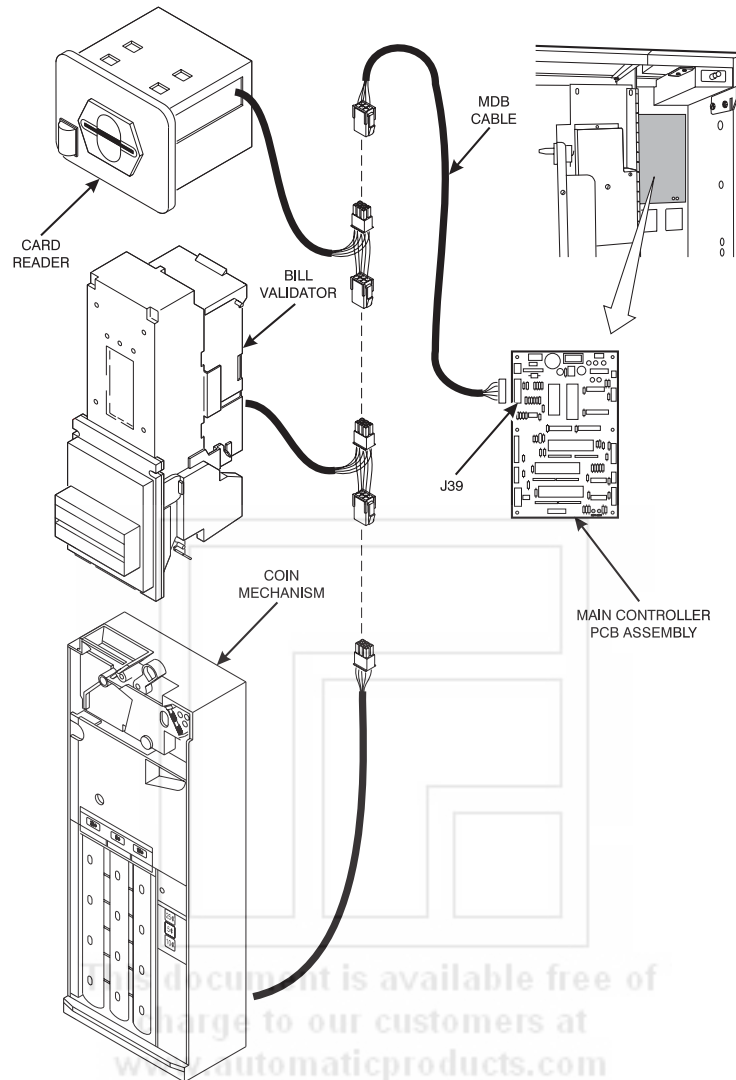

- e. The following figure shows a coin mechanism, bill validator, and card reader connected to one another via an MDB. Some monetary configurations may not include all of these devices. Connect your coin mechanism as shown:



- f. Turn ON the main power switch. Select MDB mech in the SELECT COIN MECHANISM AND OPTIONS procedure on page 44. Press  until the standby message is displayed, then press . Insert enough coins through the coin slot into the coin tubes to more than cover the empty sensor. Insert coins one at a time and ensure they lay flat in the tubes. The amount of coins you insert is internally recorded.
- g. Payout about 6 coins to ensure proper loading.
- h. Finish inserting coins through the coin slot to fill all the tubes with coins.
- i. Visually check the coin tubes to make sure coins are not shingled.

7. Fill the Tank:

- a. Make sure the main power switch is ON.
- b. Turn on the water at its source.
- c. On the service keypad, press , then press  until the display shows TANK.FILL.
- d. Press . You should hear water running into the tank, and the display will show FILLING.
The water will run until either the tank is full or 12 minutes go by, whichever happens first.

NOTE

The inlet water valve only stays open for 12 minutes at a time. This is a safety feature to prevent water from running into a leaky system and making a mess. It is possible for your tank to take longer than 12 minutes to fill if your location has low water pressure. To be on the safe side, check for leaks if the water runs a long time. If you find none, everything is normal; you just have low water pressure.

- e. When you hear the water stop running, repeat steps 3 and 4. Under normal circumstances, nothing will happen. If water starts running and the display shows FILLING again, your pressure is low and it is just taking a long time to fill the tank. Repeat this step if necessary to be sure your water tank is full.

8. Fill the Canisters:

Open the lid as shown, and carefully pour the appropriate product into the canister. Repeat for all canisters in the machine.

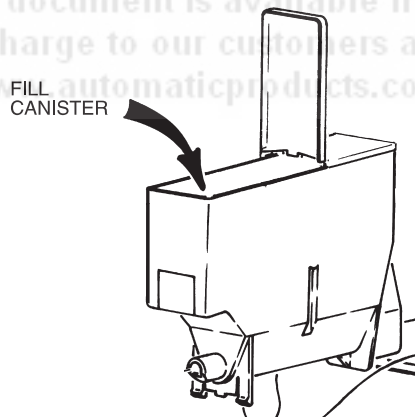

9. Load Cups:

CAUTION

Use only cups which have been designed for use in a hot beverage vending machine.

- a. Support the cup mechanism in the upright position.
- b. Push the latch forward to release the cup mechanism. Continue to support the cup mechanism while you lower it into the loading position.
- c. Remove the turret cover.





OBSERVE PROPER HYGIENE - DO NOT TOUCH THE CUPS!

- d. Open the bottom of the wrapper on a stack of cups.
- e. Insert the wrapped cups into the turret and pull the wrapper out.

DO NOT FILL CUPS ABOVE THE LEVEL MARKED ON THE OUTSIDE OF THE CUP TURRETS OR ABOVE THE "FILL LINE" LABEL INSIDE EACH TURRET, OR MOTOR JAMS WILL OCCUR. USE ONLY THE SAME SIZE AND BRAND OF HOT DRINK CUPS IN EACH TURRET; DO NOT INTERMIX!

- f. Replace the turret cover after the turrets have been loaded.
- g. Be sure the cup mechanism is locked into the upright position.

10. Cup Size(s):

- a. Make sure the cup sizes you select agree with the cups you have actually loaded during setup.
- b. Press  , the display shows X OZ Y. "X" is the currently selected drink size for the cups in turret 2 (normally large cups), "Y" is the currently selected drink size for the cups in turret 1. (Normally regular cups).
- c. Press  to change the #1 cup ring size; press  to change the #2 cup ring size.
- d. Any changes made to the cup sizes must be "locked in". There are two ways to do this:
 - i. If you are keeping some cup sizes the same, or putting the cups in different cup rings, press and hold  . The display momentarily shows CLEARING, two beeps sound, then shows FINISHED. This will reassign the old throw times to the new cup ring, if possible.
 - ii. If you are loading all different size cups, or want to load all new default times, press and hold  . The display momentarily shows CLEARING, two beeps sound, then shows FINISHED. This will reload the factory default times you have established.
- e. CONTINUE.

11. Test the Machine:

Your HotCup merchandiser is now ready to vend coffee, just as soon as the water in the tank



reaches its operating temperature. Press , and a reading of the tank temperature is displayed. When the display shows 94° C (202° F), it is ready for vending.

- a. Close the door, make a selection, and enjoy your cup of coffee!
- b. You will now need to do the following before your machine is ready to start earning money:
 - Set prices
 - Set up the menu
 - Establish time of day vending periods (if desired)
 - Customize the drink recipes (if desired)
 - Set up custom messages (if desired)

Refer to the Programming section for details on these and other procedures.

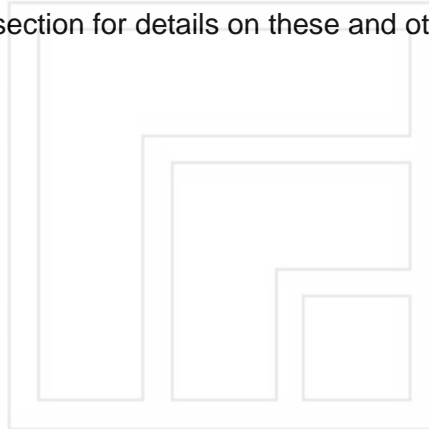

This document is available free of
charge to our customers at
www.automaticproducts.com

12. PosiVend™

PosiVend™ ensures that a cup is always available in the cup station before any money is collected or product delivered. The sensing system is a beam of infra-red light across the cup station which is broken by the cup when it falls into position.

The PosiVend™ software monitors the cup station sensor during the time the cup ring is cycled and for three seconds afterward. If a cup is not detected, the software will first determine if a second cup ring with the same size cups exists and will then try to drop a cup from the second ring. If the second ring also fails to drop a cup or is not usable, the software will repeat the attempt from the first cup ring to attempt to clear any jams in the cup delivery area. Each ring will be tried up to two times. If a cup is still not detected by the infrared sensor then several things happen:

- Any ring that failed twice in a row is placed temporarily out-of-service for a length of time that is determined by the user,
- The customer's credit is either restored for another vend attempt or is returned automatically,
- Three beeps are sounded and the message SELECT ANOTHER SIZE is flashed if another size cup ring is available, or the message INSERT MUG is flashed in the event that no other cups are available. The customer may always get his money back by pressing the coin return button.

Insert mug is the default message.

You may customize this message if desired.

Special rules exist to protect both the customer and the operator from loss. First and foremost, the customer is protected because no drink is spoiled nor money lost because a cup fails to fall to the cup station. The customer is given every chance to get his original choice of cup size by trying at least twice per ring to eject a cup. If two rings are available with the same cup size, the system will alternately try to vend a cup from each ring until the cup is delivered or both rings are placed out-of-service.

The operator is protected by the anti-jackpot program of the system. It is conceivable that a customer could prevent cups from reaching the sensing area of the cup station in order to steal the cups and then get his or her money back for the vend. Under the PosiVend™ Anti-Jackpot system, the operator can lose no more than two cups in a row per ring. Then that ring is temporarily placed out-of-service both to protect the customer and to discourage theft. The amount of time that the cup ring is out-of-service is programmable from 0 to 99 minutes. After the time has elapsed, the cup ring will return to service but the count of the two failures is kept. If the previous problem was theft, then the next vend attempt from that ring will be successful and the count of the two previous failures will be erased. If the problem is an actual system failure, then the third failure will permanently place that cup ring out of service until a service technician visits the machine.

Alternate cup vends and mug vends still work as before. If a cup ring is out of service due to PosiVend™ the alternate vend will only be from a selected large cup to a small cup at the small cup price. An induced PosiVend™ failure cannot cause an alternate vend from a selected small cup to a large cup at the small cup price. This protects the operator from customers trying to get large cup drinks at a small cup price. (PosiVend™ will not automatically switch to a different cup size in mid-vend because it cannot be ensured that correct change will be returned for the new price.)

PosiVend™ can be turned off if desired, (See "Turn PosiVend™ On or Off" on page 68).

V. Adjustments and Minor Maintenance

1. Empty the Bill Stacker

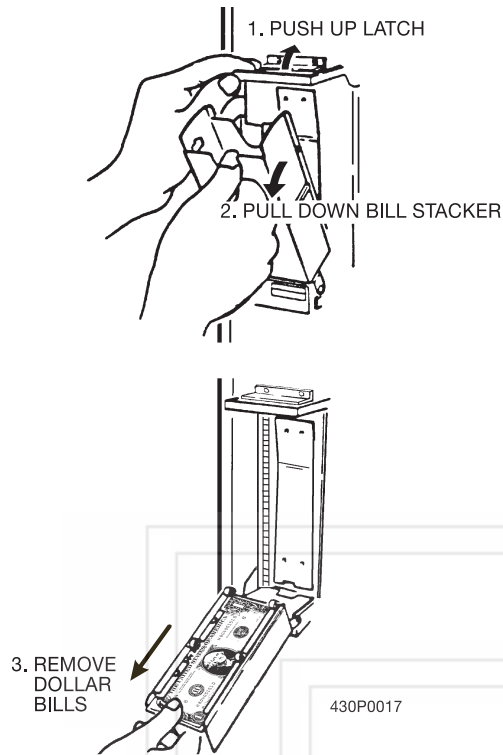

2. Adjust the Water Valves

Water valves do not usually require adjustment, but in some cases adequate water volume cannot be achieved by the throw time setting alone (See “Programming The HotCup” on page 34). If absolutely necessary, adjust the valves in conjunction with setting the factory default timers during the Product Configuration programming mode.

- a. Using a slotted screwdriver, turn the adjustment screw clockwise to decrease the water flow rate.
- b. Turn the adjustment screw counterclockwise to increase the water flow rate.

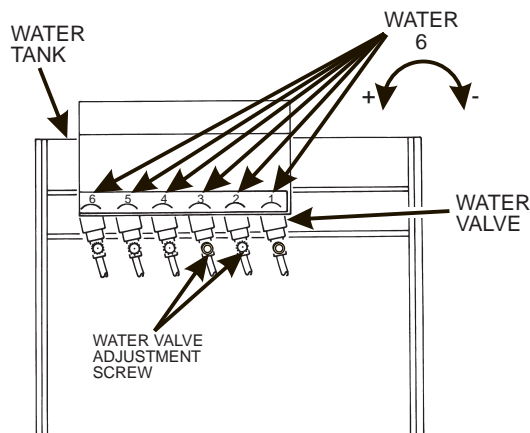

3. Install Canisters

- Place the canister in position as shown.
- Engage the pins on the motor shaft with the slots in the canister coupler.
- Fit tabs on canister into the slots on the canister shelf.
- To ensure canister is correctly engaged with the rear mounting bracket, gently push down on the front edge of the canister lid.

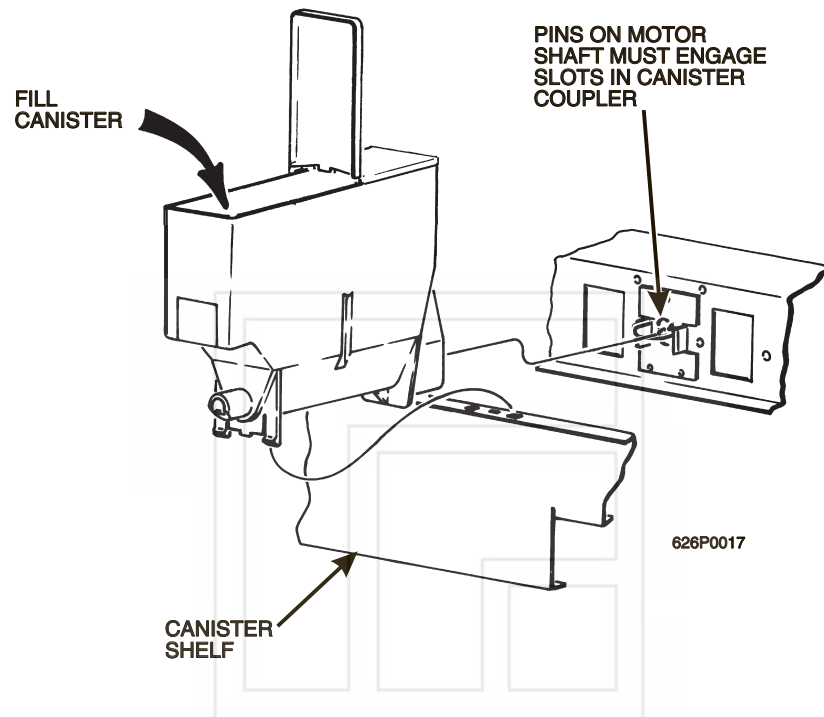

4. Modify Canister to Vend 12oz Cups (Optional)

- Remove all cups, then remove the turret center and turret base assembly from the canister.
- Break off all 8 tabs on the bottom of the turret base as shown.

NOTE

**You will no longer be able to vend smaller cups from this canister!
To return to vending smaller cups, you must replace the modified
turret base with an original turret base (part number 6233048)
from National Vendors Parts Department.**

- Replace the turret center and turret base in the canister and load cups.
- Drop a cup. If it drops properly, you are finished with the procedure, if not, continue with step e.
- Remove all cups, then remove the canister from the cup mechanism assembly.
- Remove the funnel, replace the canister, and reload cups.

- g. Drop a cup. If it drops properly, you are finished with the procedure, if not, continue with step h.
- h. Order a 5 oz/18oz cup ring (part number 6233120) from you local GPL Distributor.

5. Adjust the Cup Mechanism.

- a. Place seven cups in the cup ring.
- b. Observe the clearance as shown in view B.
- c. If necessary adjust by first loosening the adjustment arm screw (view A).
- d. Move adjustment arm until correct clearance is achieved.
- e. Hold adjustment arm in place and tighten adjustment arm screw.

View A

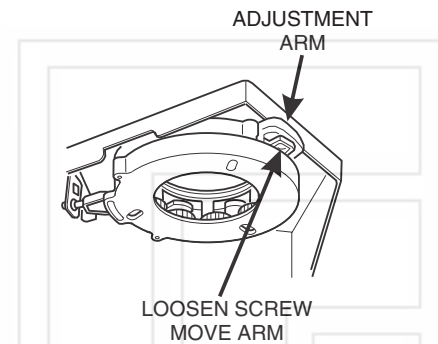

View B

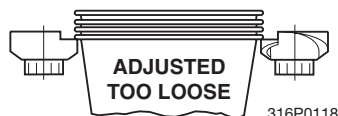
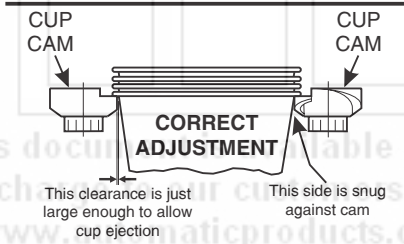

6. Set Up the Menu Assembly.

- a. From the inside of the door, remove screws as indicated in the figure below.
- b. Remove the menu board.
- c. Set up the menu board as desired and reinstall it in the reverse order of disassembly.

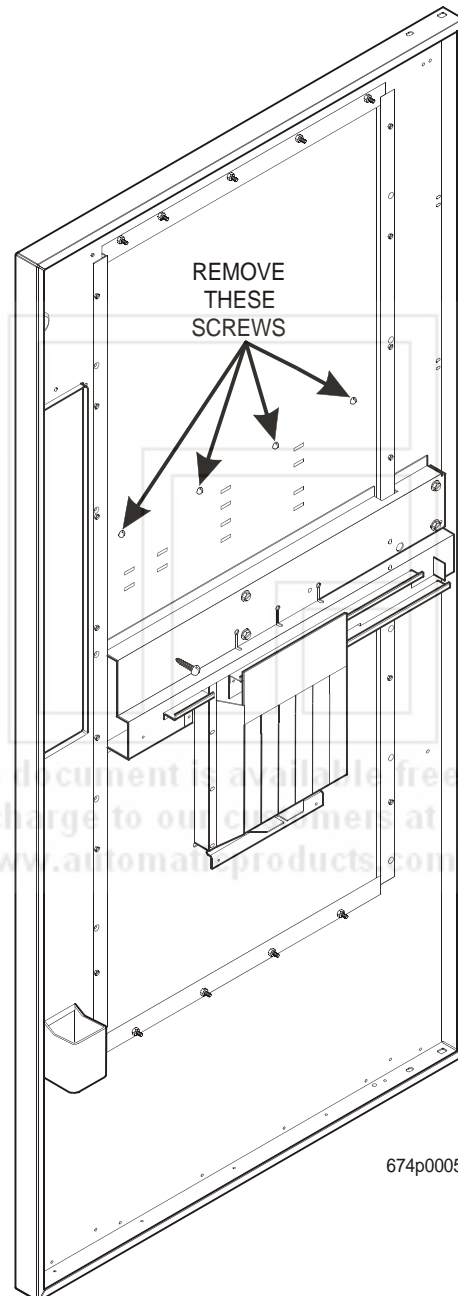

Programming The HotCup

I. Getting Around

Getting around the HotCup software is pretty easy once you know the features that are available to you, and how to use them. The three main parts you will use are the SERVICE KEYPAD, the SELECTION SWITCH PANEL, and the DISPLAY.

II. The Service Keypad

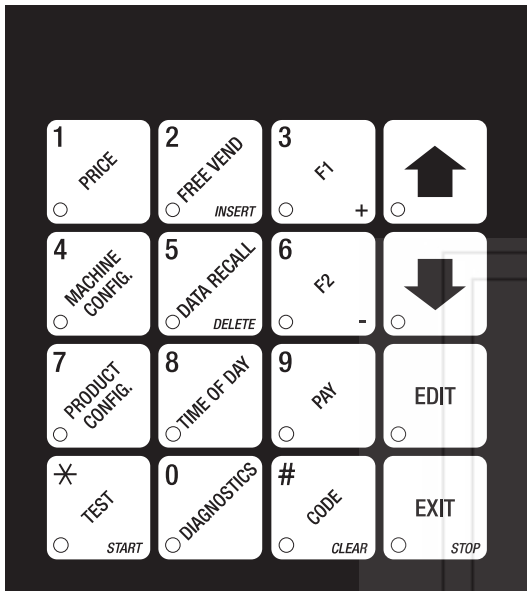

For most of your programming jobs, you will be using the service keypad conveniently located on the monetary panel. The service keypad has 16 keys. The three columns on the left are the mode keys. The right hand column contains the movement keys.

III. The Selection Switch Panel

The selection switch panel is also located on the monetary panel. Unlike the service keypad, it is accessible when the cabinet door is closed. These are the keys the customer will use to make selections. You can also use these keys during programming procedures.

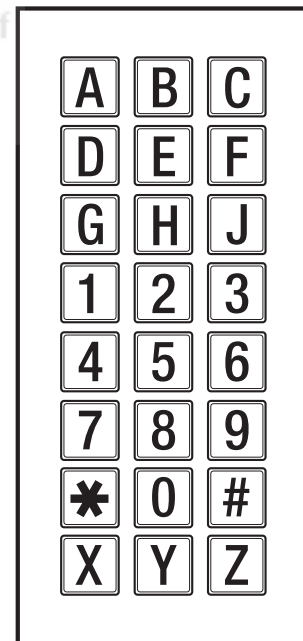

636P0044

IV. The Display

The 10-character display performs two functions, and is referred to in this book as "the display":

1. It shows the customer's selection and how much credit is in the machine, as well as the ready, service, and time of day messages.
2. It provides information and feedback to the service person during maintenance.



V. The Function Keys

The FUNCTION keys on the service keypad can be used for up to three things:

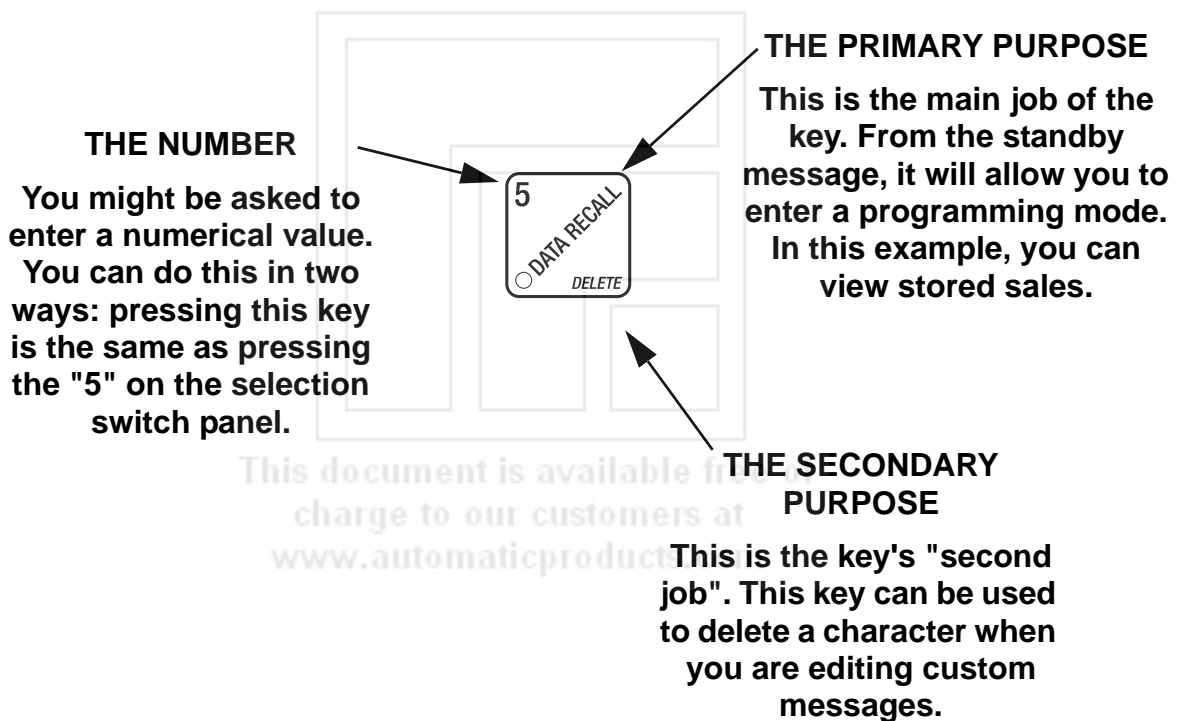

VI. Other Keys

The MOVEMENT keys on the control panel let you move inside a mode, and back and forth between modes. To see how these keys let you move around, study the flow diagram on the next page.



The up and down arrow keys are your "legs", which let you move up and down the list of tasks. These keys are what let you continue from one step to the next in programming procedures.



This is your "activate" or "choose" key. It "opens a door" to additional information and lets you begin a programming task once you are inside of a mode. Sometimes, it is used as a toggle switch to show you your choices during a programming task.



This is your "end" key. Pressing it one or more times will move you back to the start of the mode, or all the way back to the standby message.



This key lets you start an action, such as a test.

VII. Control Panel Switches Explained



Press this button to put your machine into the Price Setting mode. You can see maximum and minimum machine prices, and change prices for entire machine or individual selection.



Press this button to set up how the Free Vend mode will operate.



Press this button to view the water tank temperature, software version number, machine and accessory configuration, and active selection status.



Press this button to:

- Select display language
- Select coin mechanism and options
- Select bill validator and options
- Select card reader and options
- Select monetary options
- Set winner feature



Press this button to:

- View total sales and vends by whole machine, selection, or drink size
- Clear resettable data
- View or set machine



Press this button to:

- Download data into your portable data collection device (PDCD), **OR**
- Set printer baud rate, depending upon which device you are using



Press this button to:

- Set machine type configuration
- Set which selections are active
- Set up blended selections
- Set up cup sizes



Press this button to:

- Set time of day
- Set day, month, year
- Select display messages
- Set up time of day intervals for inhibit, freevend, and discount vending
- Edit messages
- Set message scrolling speed



- Press this button to pay one or more coins from the coin mechanism.



- Allows you to see any fault or condition that has placed the machine out of service



Press this button to:

- Perform test vends
- Test machine functions
- Test displays
- Fill the water tank



Press this button to:



- Enter the SUPERVISOR mode
- Change the SUPERVISOR access code
- Lock and unlock access to functions

This document is available free of charge to our customers at www.automaticproducts.com

Programming Procedures

Some Conventions

The pages that follow contain all the programming procedures for the HotCup. If you need to do a specific task, you can find it immediately by using the Programming Index. Most of the procedures have things in common, and here is a short guide to help you through these conventional presentations:

- All programming procedures assume that you are starting with the standby message showing in the display. If not, just press  until you get there.
- To exit a mode (CONTINUE) at any time, press . Sometimes you may have to press the key more than once in order to exit all the way to the standby message.
- Text that looks like this: **DISPLAY** represents what you will see in the display on the monetary panel.
- Definitions and helpful information will appear in shadow boxes: 

The Supervisor Mode

The supervisor is allowed to do things that a normal user cannot, like controlling access to certain modes. The supervisor can lock out any of the programming modes to anyone who does not have the right "key". Once a supervisor enters the proper code, he or she will be able to:

- Change the supervisor access code
- Lock out any or all of the service keypad modes
- Select whether price lines are used
- Set whether data is cleared after being downloaded into a portable data collection device
- Grant or deny access to data items during **DATA RECALL**
- Modify the machine configuration

Gain Access to the Supervisor Mode



- Press . The display shows: **ENTER CODE**. You must enter the four-digit supervisor code within 6 seconds to gain access.

NOTE

A new machine has a factory-set supervisor code of 0000.

- When you have entered the right code, you will hear two beeps and see **UNLOCKED** in the display.

Enter a New Supervisor Code

- a. Follow the steps in (See "Gain Access to the Supervisor Mode" on page 38).
- b. Press , then  until the display shows **SUPER XXXX**. The X's represent the current supervisor code. Use the number keys to enter a new code.

IMPORTANT!

**If you enter a new code, be sure to keep a written record of it.
There is no other way to access the SUPERVISOR mode.**

Enter a FreeVend Code

- a. Follow the steps in (See "Gain Access to the Supervisor Mode" on page 38).
- b. Press  until the display shows **FREE XXXX**.

The X's represent the current freevend code. Use the number keys to enter a new code. If the code is anything other than "0000", it must be entered after the key lock is turned in order to enable free vends.

Lock or Unlock Mode or Payout Keys

- a. Follow the steps in (See "Gain Access to the Supervisor Mode" on page 38).
- b. Press  until the display shows either **X. LOCKED** or **X. UNLOCKED**. "X" refers to the number or character shown on the mode or payout key in question (1 through 9, # and *). To see if a key is locked or unlocked, press that key.
- c. Press to change between locked and unlocked. When anyone other than the supervisor tries to enter a locked mode, the display shows **LOCKED**.

NOTE

The following mode keys cannot be locked out:



Set the Printer Baud Rate

- a. Press . The display will show one of the following rates:

BAUD 1200, BAUD 2400, BAUD 4800, or BAUD 9600.

- b. Press  until the desired baud rate is displayed.

NOTE:

**This baud rate must match that of your printer,
or it will not function properly.**

Set Printer or DEX Options

- a. Follow the steps in (See “Gain Access to the Supervisor Mode” on page 38).

- b. Press  until the display shows:

PRINTER means that data will be sent directly to a printer,

– OR –

DEX ONLY means that data remains in memory after it is downloaded into a portable data collection device (PDCD),

– OR –

DEX +CLR means that resettable data is cleared after it is downloaded into a PDCD.

- c. Press  to change between the three choices.

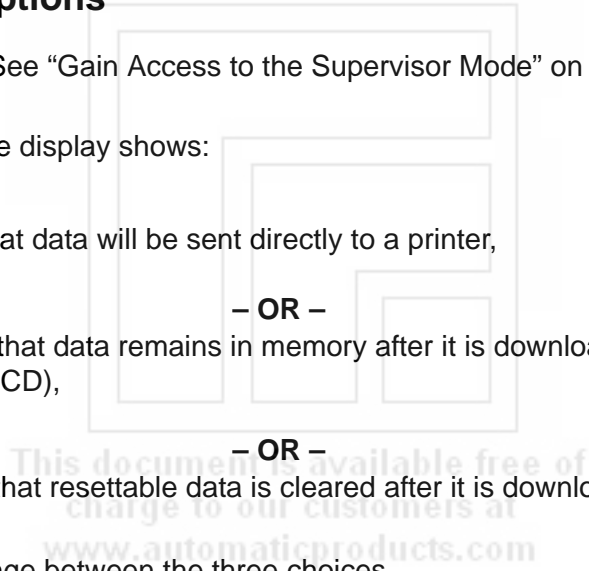

Set Up The Optional Printer

The printer allows you to obtain a hard copy of data from the HotCup Center. This data includes:

- Machine ID number
- Time and date of printout
- Price of each selection
- Mug discount
- Dollar value of sales for all selections
- Sales counts for all selections

Printing is very simple:



- Open the machine door and locate the printer cable. (You may need to open the monetary panel.)
- Make sure the baud rate selected in the MACHINE CONFIGURATION function agrees with your printer's baud rate.
- Connect the printer to the printer cable.
- Turn the printer power ON.
- The display shows **PRINTER**. You are now in the printer mode.

NOTE

Pressing  causes you to leave the printer mode. To reenter printer mode, press



while the printer is connected and turned on.

- To print all prices, press . The printer begins printing. the machine display scrolls "*** " until the data has been downloaded, then it returns to **PRINTER**. The printer may continue printing for a while longer.
- To print product configuration, press . The printer begins printing. The machine display scrolls "*** " until the data has been downloaded, then it returns to **PRINTER**. The printer may continue printing for a while longer.
- To print sales information, press . To customize your printout, refer to the MACHINE CONFIGURATION function. The printer begins printing. the machine display scrolls "*** " until the data has been downloaded, then it returns to **PRINTER**. The printer may continue printing for a while longer.
- When the printer is unplugged or turned off, the machine display will once again show the normal standby message.

DEX/UCS Interface Operation

Connect your portable data collection device (PDCD) to the harness hanging inside the monetary door, and operate it per its instructions.

SELECT DATA TRANSFER METHOD:

1. Press . The display shows: **ENTER CODE**. You must enter the four-digit supervisor code within 6 seconds to gain access.

NOTE

A new machine has a factory-set supervisor code of 0000.

2. When you have entered the right code, you will hear two beeps and see **SUPERVISOR** in the display.

3. Press  until the display shows **DEX.CLR ON** or **DEX.CLR OFF**.

DEX.CLR ON = Data will be cleared after collection is complete.

DEX.CLR OFF = Data will remain in merchandiser memory after collection is complete.

4. Press  to switch between the two options.



5. Press  to exit.

This procedure does not need to be repeated unless you desire to change the data transfer option. However, it might be prudent to check the setting prior to download to ensure unintentional clearing of data.

DOWNLOAD DATA:

- Press . The display shows **DEX.MODE** while data is being transferred.



Lock or Unlock Data Clearing Access

- a. Follow the steps in (See "Gain Access to the Supervisor Mode" on page 38).
- b. Press  until the display shows either **#. LOCKED** or **#. UNLOCKED**. **LOCKED** means that non-supervisors cannot clear resettable machine sales and vend data from the  key.
- c. Press  to switch between **#. LOCKED** and **#. UNLOCKED**.



NOTE

The supervisor can clear data regardless of this setting, provided the supervisor code was correctly entered first.

Select Display Language

Press . The current LANGUAGE is shown in the display. Press  to choose the desired language. Your choices are: **ENGLISH, DEUTSCH, FRANCAIS, ESPANOL, PORTUGUESE, SWEDISH, or NEDERLANDS**.

Select Coin Mechanism and Options

a. Press , then press  until the current COIN MECHANISM is shown in the display.

b. Press  to choose the desired coin mechanism. Your choices are: **DUMB MECH**, **MDB MECH**, **EXEC MECH**, or **NO MECH**.

NOTE

If you selected EXEC MECH you can exit the function.

c. Press  until the display shows **CHANGE X.XX**.

Coins and bills which are less than or equal to this value will be returned without a purchase being made.

Examples:



CHANGE 0.00 Forced vend; NO change returned without a purchase.

CHANGE .25 Nickels, dimes, and quarters returned without purchase.

CHANGE 1.00 \$1 bills and SBAs will be returned as change without purchase. Nickels, dimes, and quarters are also returned.

d. Press  until the display shows: **LOW.MSG X.XX**. The display will show **USE EXACT CHANGE** when the amount of available change in the coin mechanism falls below the value of "X.XX". Enter a value with the number keys. For example, if **LOW.MSG 1.00** is displayed, the **USE EXACT CHANGE** message is displayed when less than a dollar's worth of change is in the coin mechanism.

Select Bill Validator and Options

Press , then press  until one of the following is displayed:

NO DBV

No bills will be accepted or there is no bill validator installed (you can exit the function).

SER.1.2.5.10.20

The serial bill validator is selected and will accept \$1, \$2, \$5, \$10, and \$20 bills. Use BILL SELECTION METHOD below to change the bills which will be accepted.

MDB.1.2.5.10.20

A standard MDB bill validator is selected. It will accept \$1, \$2, \$5, \$10 and \$20 bills. Use BILL SELECTION METHOD below to change the bills which will be accepted.

BILL SELECTION METHOD:

The standard \$1, \$2, \$5, \$10 and \$20 bills are enabled by pressing the **1, 2, 5, 6, or 7** key(s), respectively, to display which bill(s) will be accepted.



MDB. <*>

An MDB bill validator which accepts nonstandard bills or tokens is

connected and operating. Press  to enter list of bills.

(See "Initial Setup of a Nonstandard Bill Validator" on page 46).

BILL LIST OPERATION:

Use  and  to scroll through the list of bills.

Use  to turn the bill acceptance **ON** or **OFF**.

Use  to move up to the top level screen.

1. 1.00 ON

1. = Bill validator channel 1, each bill has its own channel

1.00 = Bill value

ON = \$1.00 bill will be accepted

1. 1.00 OFF

OFF = \$1.00 bill will not be accepted

TKN

Token bills (same as coupon bills)

Initial Setup of a Nonstandard Bill Validator

a. Connect the bill validator, select **MDB** in the bill validator selection screens. The standard "MDB.1.2.5.10.20" screen will appear first.

b. Exit the bill validator setup by pressing . Bill information is now collected from the validator. Re-enter the bill validator selection screen and the nonstandard screen "MDB.<*>" will appear.

PULSE DBV The pulse bill validator will accept \$1 bills. Press  to choose the desired option.

Select Monetary Options

This function lets you:

- Set declining balance,
- Set currency acceptance on low change,
- Set overbuy options,
- Set last bill stacking options

Declining Balance Once Credit is established, multiple vends may occur until the coin return is pressed

a. Press , then press  until one of the following is displayed:

DECLINE.ON - More than one vend is allowed, with a declining balance.

– OR –

DECLINE.OFF - A declining balance is not allowed.

b. Press  to display the desired choice.

c. Press  until one of the following is displayed:

ACC <\$\$ X.XX The last bill which meets or exceeds maximum price will be held in escrow.

– OR –

ACC.STK X.XX The last bill which meets or exceeds maximum price and MDB coupon bills (token bills) will be immediately stacked.

Example: If setting is **ACC.STK 1.00** and maximum price is \$1.50. This setting will immediately stack the second \$1.00 bill inserted.

- d. Press  to display the desired choice.

The value of "**X.XX**" has two purposes:



- i. First, "**X.XX**" tells the machine how big a bill or coin to accept even though there is not enough change in the coin mech to cover all possible paybacks.
- For example, enter **1.00**. The machine will take a dollar bill or coin even though there is less than \$1.00's worth of change. Entering **5.00** tells the machine to take a five even though there is less than \$5.00's worth of change, and so forth.

NOTE:

This could cause a customer to be shortchanged.

- Entering **0.00** means that bills or coins will only be accepted if there is enough change to cover them.
- ii. The value of "**X.XX**" tells the machine how much the customer is allowed to overbuy a product. The customer will be shortchanged when an overbuy occurs.
- For example, for a value of \$0.25: if there is no change in the machine and the customer inserts a \$1.00 bill. The customer can purchase a product for \$0.75 even though the change cannot be paid back. The customer will be shortchanged. Normally a purchase will not be approved unless all change can be paid.
 - Entering 0.00 means that the vend will only be approved when the correct change can be returned (overbuy disabled).

Select Card Reader and Options

- a. Press , then press  until the current card reader is shown in the display.

- b. Press  to choose the desired card reader. Your choices are: **NO CARD**, **DUMB CARD**, or **MDB CARD**.

- c. Press  until one of the following is displayed:

REVALUE.ON Allows credit to be transferred onto the card

REVALUE.OFF Credit cannot be transferred to the card

- d. Press  to display the desired choice.

Payout Coins

- a. Press . If a dumb mech was selected, the display shows **NDQ =123**; if an MDB mech was selected the display shows **PAY 123**.
- b. Press . A dumb mech pays out one **Nickel**; an MDB mech pays a coin from tube 1.
 Press . A dumb mech pays out one **Dime**; an MDB mech pays a coin from tube 2.
 Press . A dumb mech pays out one **Quarter**; an MDB mech pays a coin from tube 3.
- c. To continuously pay out coins, hold down the appropriate key.

Set Up Winner Mode

Winner: At pre-selected intervals, a customer may receive a refund for a selection. You can select the intervals and qualifying selections.

- a. Press , then press until one of the following is displayed:

WINNER OFF Winner function is disabled.

OR

WIN XXX Winners are allowed at certain intervals, represented by "XXX".



- b. Press to display the desired choice.

If you selected **WINNER OFF**, you can **CONTINUE**. Otherwise, go to the next step.

- c. The display shows **WIN XXX**. **XXX** represents the number of vends that must occur per each winner vend. For example, an interval number of 50 means that a winner can happen any one time during the next 50 vends. Using the number keys, enter an interval number between 10 and 9999.

- d. Press . The display shows * .------. The dashes in the display represent which selections are allowed winners. Press the appropriate letter key to enable a selection; press the key again to disable it. For example, pressing **A**, **C**, and **E** will cause the display to look like this: * **A-C-E**----, meaning that all **A**, **C**, and **E** selections can have a winner.

ADVANCED OPTIONS:

- Press  to enable all selections; press  to disable all selections.
- Press **0** or **1** to enable winners by cup size.



AN EXAMPLE . . .

You want to enable winners on all selections except **E** and **F**.

Do the following:





- i. Press . The letters **A** through **J** appear in the display instead of the dashes.
- ii. Press **E** and **F**. The letters **E** and **F** in the display are replaced by dashes.

Set Up the Mug Discount

Press , then press  until the display shows **MUG DSC XX**. **XX** represents the value of the discount customers will receive for using their own mugs or cups. Enter the amount with the number keys. Enter **0** for no discount.





Assign Cup Sizes to Selections (Supervisor Mode Only)

You can load up to two different sizes of cups in your machine. You may not always want a certain selection to use all of the cup sizes in your machine. For example, espresso is normally served in regular cups, so you probably will not want it to be available in large or jumbo cups.

- a. Press , then press , until the display shows something like this: **0. ABCDEFGH**. This display means that the smaller of the two cup sizes (0) is available for selections (A-H).
- b. Press  to display all selections; press  to clear all selections.
- c. Press  to display remaining selections (**0 YZ2_ _ _ _**). In this display, the “Y and Z” represents the blended product, and the “2” represents the cup only selection.

NOTE:

If you have only one cup size in your machine, you will not see the next display.





- d. Press . The display shows something like this: **1. ABCDEFGH**. This display means that the larger of the two cup sizes (1) is available for all selections (A - H).
- e. Press the appropriate letter to toggle the display on or off. A selection that doesn't vend the displayed size cup has its letter replaced by a dash (-).
- f. Press  to display all selections; press  to clear all selections.
- g. Press  to display remaining selections (**1 YZ2_ _ _ _**).

In this display, the “Y and Z” represents the blended product, and the “2” represents the cup only selection.

To vend a cup only, press 1, 2, 3 (large size) or 2, 3 (regular size).

Set Up A Hot Drink

Be sure that the cup sizes you set for selections (See "Assign Cup Sizes to Selections" on page 50), agree with the cup sizes actually in your machine. All procedures for setting up the hot drinks are similar, so this example will demonstrate how to set up the A selection, regular size fresh brew coffee.

- a. Press , then press  until the display shows **SETUP -***. The star (*) represents the selection (A, B, etc.). The dash (-) represents the size of the selection.
- b. Press A. (If you were setting up the A selection for the large size drink, you would press 1 first, then A.) The display shows **WAT. A 12.00**. This means that the currently set water throw time for the A selection is 12.00 seconds. Enter a new time if desired.
- c. Press . The display shows **DRY. A .60**. This means that the currently set dry product throw time for the A selection is .60 seconds. Enter a new time if desired.
- d. Pressing  after each display will cause the following screens to appear:

DRY. A+ View and change the settings for an extra strong drink

SUG. A View and change the settings for the sugar throw time

SUG. A+ View and change the settings for extra sugar throw time

LIT. A View and change the settings for the lightener throw time

LIT. A+ View and change the settings for extra lightener throw time

SUB. A View and change the settings for the sugar sub throw time

SUB. A+ View and change the settings for extra sugar sub throw time

STP. A View and change the steep time

STP. A+ View and change the steep time for an extra strong drink

AIR. A View and change the air compressor/pump running time

DLY. A View and change the amount of time after the vend to open the auto vend door

Whipper Options

WHP. A XXX Press  to view and change the whipper settings as follows:

ON- The last 3 seconds of the drink is always whipped

ON+ The whole drink is always whipped

OFF The drink is never whipped

OPT See below

•If **J+** is selected (See “Set the Machine Type Configuration Code” on page 56):

OPT- The last 3 seconds of the drink is whipped only when the J key is pressed

OPT+ The whole drink is whipped only when the J key is pressed

•If **J-** is selected(See “Set the Machine Type Configuration Code” on page 56):

OPT- The last 3 seconds of the drink is whipped unless the J key is pressed

OPT+ The whole drink is whipped unless the J key is pressed

DIFFERENCES:

Some selections will not show all of these items. The E selection will have some additional selections:

WA.2 E View and set the water throw time for the cappuccino second product (chocolate)

DR.2 E View and set the chocolate throw time for cappuccino

PCT. E To automatically compute new times for cappuccino, enter a percentage, then

press . This percentage represents the amount of chocolate product in cappuccino, versus that in a normal chocolate drink. This time and the normal coffee settings will compute the new cappuccino time.



OPTIONS:

- i. At any of the preceding displays, you can press  to test throw that item.
- ii. At any of the preceding displays, you can press * or # (on the selection switch panel) to step through a list of that item's throw times for other selections where that item is active. For example, pressing # at the **WAT. A** display will show the throw time for **WAT. B**. This is a handy way to move from one selection to another without going to the **SETUP** screen first.

NOTE

If you try to set up a selection that is not configured, the SETUP screen will remain in the display.

View or Set the Hot Water Tank Temperature

- a. Press  then  until the display shows **SET 202 °F**. In this example, 202° is the water tank temperature setpoint in degrees Fahrenheit. If a decimal point appears next to the "F", the heater is on.
- b. If desired, enter a new setpoint in the accepted range of 149° - 205° F (65° - 96° C).

NOTE

The lower limit for vending is 20° below setpoint, up to a maximum of 180° F (82° C).

- c. To change display units (replace the "F" with a "C" for Celsius), press .
- d. Continue.

Set Up Low Temperature Dispensing

- a. Press  then press  until the screen displays either:

LTDIS off. This causes the machine to operate the same as the previous HotCup Center. For example, with a setpoint temperature of 202° F the machine will inhibit vending when the water tank temperature reaches 182° F.

-or-

Ltdis on. Allows vending to a water tank temperature of 140° F.







- b. Press  to change between ON and OFF.

Set Up Low Power Settings

Low power settings allow for the water tank to be set to a lower temperature at up to 4 different dates and times. For example, you want to lower the tank temperature to 160° F overnight on Mondays through Fridays. The machine tank temperature setpoint will be changed to 160° F at 6:00 pm and maintained at that temperature until 5:00 am on the following morning when the setpoint is returned to 202° F. Please keep in mind that at 5:00, the machine will just begin to increase to the 202° F setpoint temperature. It is up to you to determine how long that will take and to allow enough time for the tank to be at its proper temperature when the machine will be used. Typically, one hour is adequate to return to the normal operating temperature.



NOTE:

The machine OUT OF SERVICE condition during the low power interval will be determined by how you have set the LTDIS configuration.

- a. Press  then press  until the screen displays **LOW.PWR**.
- b. Press the number of the time interval you want to edit, or  to edit time interval 1 (we will use interval 1 for this example.)
- c. The display shows **low.pw ON** or **low.pw Off**. This display tells you whether your time interval (represented by 1) is on or off. Press  to change the condition of the time interval.
- d. If you turn an interval ON, it must be edited. You can edit a time interval now, then turn it OFF until another time.
- e. Press . The display shows **1.STRT X.XX.. X.XX** is the currently set start time. Enter a new start time (24-hour format) for this interval. To enter the time for 6:00 pm, enter 1800.
- f. Press . The display shows **1.STOP X.XX.. X.XX** is the currently set stop time. Enter a new stop time (24-hour format) for this interval. To enter the time for 5:00 am, enter 0500.
- g. Press . The display shows **1.@ - - - - -**. The dashes represent the days that this time interval is active. Pressing number keys 1 through 7 switches the days on/off. For example, press “2”, “3”, “4”, “5”, and “6”. The display now shows **1.@ - M t W t F -**.



This interval is active on Monday through Friday.

Set the Brewer Rinse Time Interval

- a. Press , then press  until the display shows **SAN.TIM X.X**. "X.X" represents the time of day (in hours and tenths of hours) the machine rinses the brewer. For example, **SAN.TIM 4.5** means that brewer rinse takes place at 4:30 am. Use the number keys to enter a new time, if desired. Range: 0.0 - 23.9 in.1 hour (6 minutes) increments.
- b. Press . The display shows **SAN.HRS X.X**. "X.X" represents how soon the machine rinses the brewer after the last brewed selection. For example, **SAN.HRS 2.5** means brewer rinse takes place 2.5 hours after the last vend. Use the number keys to enter a new time, if desired. Range: 2.0 - 12.5 hours, in.1 hour (6 minutes) increments.

Set the Bowl Rinse Time

Mixing bowl(s) can be automatically rinsed by one of two methods: You can specify a set time of day when the bowl is rinsed, or you can specify that rinsing takes place a set time after the last selection is vended.

- a. Press  then  until the display shows one of the following:

RIN.HRS 2.5 - This is how soon the machine rinses the bowls after a vend. In this example, bowl rinse takes place 2.5 hours after the last vend. Range: 2.0 - 12.5 hours, in.1 hour (6 minute) increments.

-or-

RIN.TIM 4.5 - The time of day (in hours and tenths of hours) the machine rinses the bowls. In this example, bowl rinse takes place at 4:30 am. Range: 0.0 - 23.9 in.1 hour (6 minute) increments.

NOTE:





If 24 hours passes without a vend, no rinsing will take place. This eliminates unnecessary rinsing over a weekend or holiday.

-or-

RINSE OFF - No bowl rinse takes place.





- b. Press  to switch between these options, and the number keys to enter new values.

Clear Tank Errors and Fill the Tank

- a. Press , then press  until the display shows **TANK FILL**.
- b. Press . This clears any tank error and starts filling the tank, if necessary. If it is taking a long time to fill the tank AND THERE ARE NO LEAKS, you may see **TANK ERR** in the diagnostic list again. Just press  again after making sure there are no other problems, such as a restriction in the water inlet line or a clogged water filter.

**Set the Machine Type Configuration Code
(Supervisor Mode Only)**

CANISTER MAPPING

- a. Press , then press  until the display shows Mach.type (x).
- b. Press  to enter MACH.TYPE (1).
- c. Press  until the display shows D+J+ WXYZ. “D” is the automatic delivery door status. A plus sign (+) means the door is on; a dash (-) means the door is off. Toggle this setting by pressing . “J” is the whipper setting. Toggle a plus sign (+) or a dash (-) with the J key. (See “Whipper Options” on page 52).

“W” represents the machine type, “X” is the 5th Product configuration, “Y” is the brewer configuration, and “Z” is canister mapping. The following tables give the possible values for each of the four numbers. Enter the appropriate configuration code for your machine.

MACHINE TYPE CONFIGURATION

ENTER FOR (W)	DEFINITION
1	Freeze Dried Use
5	Single Fresh Brew or Dual Fresh Brew

5TH PRODUCT CONFIGURATION

ENTER FOR (X)	DEFINITION
1	Canister 5 is not used
2	Canister 5 -Soluble Gourmet Coffee, no condiments
3	Canister 5 -Tea, receives condiments
4	Water Only (US Models only)

SINGLE BREW A machine with only one brewed selection (the second selection is freeze dried). Uses a single barrel brewer.

DUAL BREW A Machine with two brewed selections. Uses a single barrel brewer.

BREWER CONFIGURATION

ENTER FOR (Y)	DEFINITION
1	Single Brew - Coffee (Model 674)
2	Dual Brew - Coffee and decaf coffee (Model 674)
6	Freeze Dried

CANISTER MAPPING (SEE FIGURE ON NEXT PAGE)

ENTER FOR (Z)	MENU SELECTION LETTERS FOR CANISTER NUMBERS	
	2	1
1	B	A
2	A	B

Index: A=Coffee B=Decaf

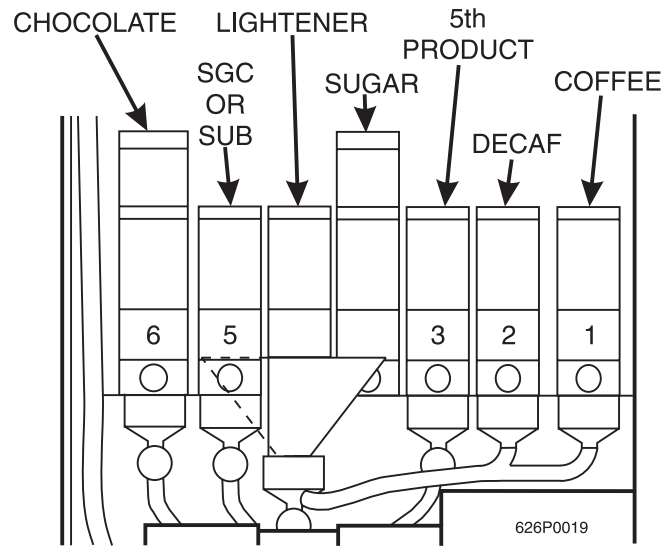

Collecting Dry Product Gram Throws

Measuring the gram throw allows you to get the right amount of dry product or condiment into your hot drink. To do this, you need a container to catch the product throw and an accurate gram scale to measure its weight.

- Make a measuring container by cutting down a paper cup until it fits under the canister spout as shown.
- Weigh the measuring cup and zero the gram scale accordingly.
- Make 5 test throws as instructed in the programming steps, then average the results.
- Weigh the test throw.
- Repeat steps 3 and 4 until you get the correct product or condiment weight.

Tables D1 and D2 show the factory default settings for the various dry products sold by the merchandiser. They are good starting points for you to use in setting up your machine. In the end, the amount of dry product or condiments you use in your drinks depends upon taste and manufacturers' recommendations. Recommended weights and times are for guidance only, and you do not have to adhere to them.

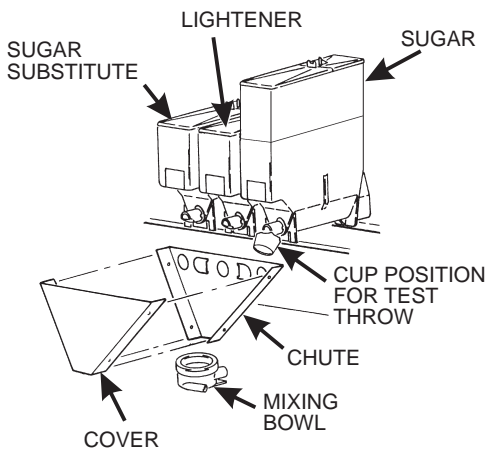

Collecting Condiment Throws

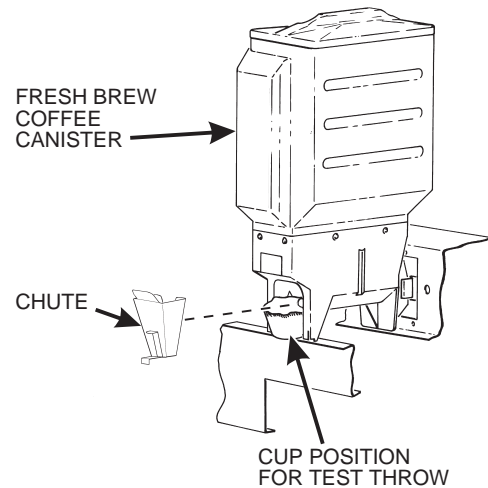

Collecting Ingredient Throws

DRY PRODUCT WEIGHT AND THROW TIME FACTORY DEFAULT SETTINGS

SELECTION		WEIGHT (IN GRAMS) PER SIZE CUP					
		THROW TIMES (IN SECONDS) PER SIZE CUP					
		5oz	7oz	8oz	9oz	10oz	12oz
A	Fresh Brew Coffee	5.70	8.00	9.00	10.00	11.00	13.00
		1.60	2.20	2.50	2.80	3.10	3.65
A	Freeze Dry Coffee	0.90	1.20	1.50	1.60	1.80	2.20
		0.35	0.50	0.60	0.65	0.70	0.90
A	Strong freeze dry coffee	1.10	1.50	1.80	2.00	2.20	2.60
		0.65	0.90	1.10	1.20	1.35	1.60
B	Fresh brew decaf	5.70	8.00	9.00	10.00	11.00	13.00
		1.60	2.20	2.50	2.80	3.10	3.65
B	Freeze dry decaf	0.90	1.20	1.50	1.60	1.80	2.20
		0.35	0.50	0.60	0.65	0.70	0.90
B	Strong freeze dry decaf	1.10	1.50	1.80	2.00	2.20	2.60
		0.65	0.90	1.10	1.20	1.35	1.60
D	Fresh brew coffee ESPRESSO	5.70	8.00	9.00	10.00	11.00	13.00
		1.60	2.20	2.50	2.80	3.10	3.65
D	Freeze dry coffee ESPRESSO	0.90	1.20	1.50	1.60	1.80	2.20
		0.35	0.50	0.60	0.65	0.70	0.90
D	Strong freeze dry coffee ESPRESSO	1.10	1.50	1.80	2.00	2.20	2.60
		0.65	0.90	1.10	1.20	1.35	1.60
E	Fresh brew coffee CAPPUCCINO	5.70	8.00	9.00	10.00	11.00	13.00
		1.60	2.20	2.50	2.80	3.10	3.65
E	Freeze dry coffee CAPPUCCINO	0.90	1.20	1.50	1.60	1.80	2.20
		0.35	0.50	0.60	0.65	0.70	0.90
E	Strong freeze dry coffee CAPPUCCINO	1.10	1.50	1.80	2.00	2.20	2.60
		0.65	0.90	1.10	1.20	1.35	1.60
F	Instant tea	0.90	1.20	1.50	1.60	1.80	2.20
		0.70	1.00	1.25	1.30	1.60	1.85
F	Strong instant tea	1.10	1.50	1.80	2.00	2.20	2.60
		0.90	1.25	1.60	1.75	1.85	2.10
G	Chocolate	17.00	24.00	28.00	31.00	34.00	41.00
		2.80	4.00	4.65	5.15	5.65	6.80
H	Soup	4.30	6.00	7.00	7.60	8.50	10.20
		0.70	1.00	1.15	1.25	1.35	1.65
H	Soluble Product	10.0	13.5	16.2	17.8	19.7	23.7
		2.45	3.35	4.00	4.35	4.85	5.80

DRY PRODUCT WEIGHT AND THROW TIME FACTORY DEFAULT SETTINGS (CONTINUED)

SELECTION		WEIGHT (IN GRAMS) PER SIZE CUP					
		THROW TIMES (IN SECONDS) PER SIZE CUP					
		5oz	7oz	8oz	9oz	10oz	12oz
D	Sugar used in espresso	2.10 0.35	3.00 0.45	3.50 0.55	4.00 0.60	4.50 0.65	5.50 0.80
D	Extra sugar used in espresso	3.00 0.50	4.35 0.65	4.80 0.75	5.35 0.80	6.25 0.90	7.20 1.05
E	Sugar used in cappuccino	3.50 0.45	5.10 0.65	6.00 0.75	6.80 0.85	7.70 0.95	9.40 1.20
E	Extra sugar used in cappuccino	4.60 0.60	6.80 0.90	7.70 1.00	8.50 1.10	9.40 1.20	11.00 1.45
F	Sugar used in tea	4.20 0.55	6.00 0.75	7.00 0.90	8.00 1.00	9.00 1.15	11.00 1.40
F	Extra sugar used in tea	5.50 0.70	8.00 1.00	9.00 1.15	10.00 1.25	11.00 1.40	13.00 1.65
F	Lightener used in tea	1.20 0.70	1.50 0.85	2.00 1.15	2.50 1.45	3.00 1.70	4.00 2.25
F	Extra lightener used in tea	1.50 0.85	2.00 1.15	2.50 1.45	3.00 1.70	3.50 2.00	4.50 2.60
F	Sugar substitute used in tea	0.60 0.75	0.85 1.05	1.00 1.25	1.10 1.35	1.30 1.60	1.50 1.90
F	Extra sugar substitute used in tea	0.80 1.00	1.10 1.35	1.30 1.60	1.40 1.75	1.60 2.00	1.90 2.40
-	Sugar	4.20 0.55	6.00 0.75	7.00 0.90	8.00 1.00	9.00 1.15	11.00 1.40
-	Extra sugar	5.50 0.70	8.00 1.00	9.00 1.15	10.00 1.25	11.00 1.40	13.00 1.65
-	Lightener	1.20 0.70	1.50 0.85	2.00 1.15	2.50 1.45	3.00 1.70	4.00 2.25
-	Extra lightener	1.50 0.85	2.00 1.15	2.50 1.45	3.00 1.70	3.50 2.00	4.50 2.60
-	Sugar substitute	0.60 0.75	0.85 1.05	1.00 1.25	1.10 1.35	1.30 1.60	1.50 1.90
-	Extra sugar substitute	0.80 1.00	1.10 1.35	1.30 1.60	1.40 1.75	1.60 2.00	1.90 2.40

D= Espresso E= Cappuccino I= Chocolate times for cappuccino

* The actual gram weight of a product or condiment throw will vary depending upon the type of product or condiment used. The weights given are approximate based upon factory testing.

- Separate sugar, lightener, and sugar substitute timers are available for selections A/B/C, D, E, and F.

Cappuccino

Cappuccino is made with various ratios of chocolate to coffee, according to taste. Lightener (E timer) is also used for cappuccino. For an example, the default chocolate-to-coffee ratio of 15/85 in a 8.25 oz. cup consists of the following:

- A chocolate throw (DR.2) lasting .65 seconds, providing 15% of the normal chocolate throw (approximately 5.4 grams*).
- A water throw for the chocolate (WA.2) lasting 2.65 seconds (chocolate product throw plus 2 seconds to ensure the mixing bowl is fully rinsed). The volume is about 59 ml, depending upon how the flow rate is adjusted.
- A throw for cappuccino coffee (product E) equal to a normal coffee (product A) throw.
- A water throw for the freeze dry coffee selection (water E) lasting for 5.55 seconds (132 ml).

OR

- A water throw for the fresh brew coffee selection (water E) lasting for 5.55 seconds (153 ml).
In either case the water volume is enough to fill the remainder of the cup.

The actual mixing sequence is as follows:

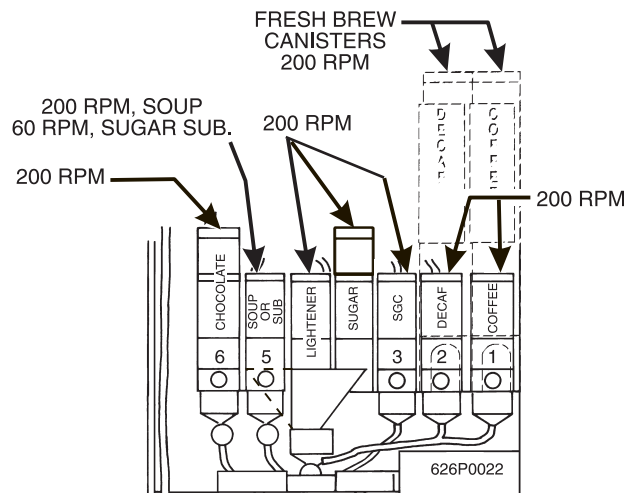

- The coffee portion of cappuccino is made using the same canister/valve combination as the normal (A) coffee.
- After the coffee is completely in the cup, the chocolate portion is made with the selection G canister/valve combination. This gives the drink its traditional "layering"

*** Chocolate weights will vary with different brands.**



MOTOR SPEED BY LOCATION

HINTS:

To “fine tune” your Cappuccino drink to your exact taste, set a ratio close to what you like (between 5% and 50%). Adjust the individual timers using  and  until you are satisfied. You may find it necessary to cut down on the amount of sweetener available to a cappuccino drink with a high ratio of chocolate, as the chocolate contains sweetener of its own.

Caffe Latte

Caffe Latte has a rich, robust coffee flavor. It is a full-bodied hot beverage with extra creamer, whipped to frothy perfection, with sugar optional. Try this recipe to expand your gourmet product selections and increase premium pricing opportunities.

Follow the instructions in the PRODUCT CONFIGURATION section of this HotCup Operators' Guide.

- a. Make sure the machine is configured to use 12 oz. cups.
- b. Set up the 1D selection as follows:
 - a. Coffee: 17 grams
 - b. Sugar: 2.5 grams
 - c. Lightener: 5 grams
 - d. Water: 6 ounces (about 177 ml)
 - e. Steep time: 12.5 seconds
 - f. Whip: ON +

To get these measurements, refer to **PRODUCT CONFIGURATION**.

See **COLLECTING DRY PRODUCT GRAM THROWS**, and perform test throws of the dry ingredients. See **COLLECTING WATER THROWS**, below, and perform test water throws.

Collecting Water Throws

GPL recommends the factory default times be used for water throws to ensure proper mixing. Table W1 gives the factory default water throw times for the various size cups and product selections.















WARNING

Water is EXTREMELY HOT! Be careful.

For a non-brewed selection, collect the water throws as follows:

- a. Place a cup in the cup delivery station.
- b. Ensure the merchandiser is using the factory defaults for the cup sizes (refer to PRODUCT CONFIGURATION).
- c. Initiate the water throw for a selection.
- d. Remove the cup and pour the water into a graduated cylinder.
- e. Refer to table W1 for the correct volume of water.
- f. Adjust the water valve for that selection and repeat steps 3 through 5 until the correct volume of water is thrown.

For a brewed selection, collect the water throws as follows:

- a. Place a cup in the cup delivery station.
- b. Press .
- c. Press  to brewer test.
- d. Press  twice to clamp brewer closed.
- e. Press .
- f. Press .
- g. Press  to setup.
- h. Enter "A" or "B".
- i. Press . (Listen for water valve to close.)
- j. Press  to air (pump).
- k. Press . (Collect throw.)
- l. Press  twice.
- m. Press .
- n. Press  to brew.
- o. Press  to home brewer.
- p. Press .

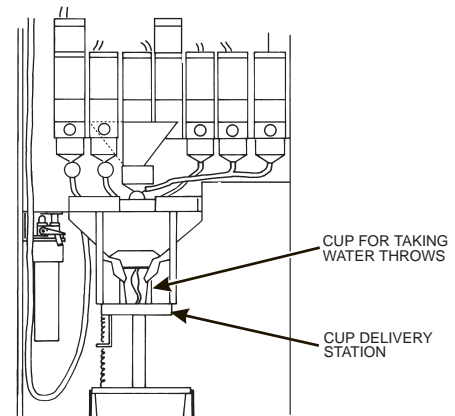



WATER THROW DEFAULT TIMES AND VOLUMES

Selection		Time (in seconds) per size cup					
		Volume (in mL) per size cup					
		5oz	7oz	8oz	9oz	10oz	12oz
A	Fresh brew coffee	4.50 130	6.40 190	7.50 220	8.20 240	9.00 265	11.00 315
B	Fresh brew decaf	4.50 130	6.40 190	7.50 220	8.20 240	9.00 265	11.00 315
A	Freeze dry coffee	4.95 120	7.00 170	8.25 200	8.65 210	9.90 240	12.60 305
B	Freeze dry decaf	4.95 120	7.00 170	8.25 200	8.65 210	9.90 240	12.60 305
C	5th Product	4.85 100	6.80 140	8.25 170	8.75 180	9.70 200	11.65 240
D	Espresso (FB)	2.25 65	3.20 95	3.75 110	4.10 120	4.50 133	5.50 158
D	Espresso (FD)	2.50 60	3.50 85	4.15 100	4.35 105	4.95 120	6.30 153
G	Chocolate	4.85 100	6.80 140	8.25 170	8.75 180	9.70 200	11.65 240
H	Soup	4.80 110	6.95 160	8.25 190	8.70 200	10.00 230	12.15 28H
H	Soluble Product	4.85 100	6.80 140	8.25 170	8.75 180	9.70 200	11.65 240

Lock or Unlock Selections

- a. Press . The display shows **LK. - - - - -**. This shows a list of selections that are locked. Here, all selections are unlocked because they show up as dashes (-). Press the appropriate selection letter to switch from locked to unlocked and back again. For example, to lock out the "A" and "C" selections, press those letter keys on the selection switch panel. For this example, the display will show **LK. A - C - - -**.

Selections can be LOCKED OUT (made unavailable for vending). You may want to do this if there is a problem with that selection, such as no product in the canister.

- b. You can lock all selections at once by pressing .
- c. Unlock them all at once by pressing .

Disable Selections in the Merchandiser

- a. Press , then press  until the display shows something like this:

LK. ABCDEFGH. This display means that all regular size selections

(A - H) are not available for vending. An available selection has its letter replaced by a blank space.

- b. Press  to display the second screen for X, Y, and Z selections.
- c. Press the appropriate letter to toggle the display on or off.



NOTE

Press  to lock all selections; press  to unlock all selections.



Rinse the Brewer

WARNING

Very hot water will be dispensed in this test. Coming into contact with hot water will HURT!

- a. Press , then press  until the display shows BREW RINSE.
- b. Press  to rinse the brewer. The brewer cycles, and RINSING is displayed.

Fill the Tank



- a. Press , then press  until the display shows TANK.FILL.
- b. Press . This clears any tank error and starts filling the tank, if necessary.

NOTE

If it is taking a long time to fill the tank AND THERE ARE NO LEAKS, you may see TANK ERR in the diagnostic list again.

- c. Just press  again after making sure there are no other problems, such as a restriction in the water inlet line or a clogged water filter.

Turn PosiVend™ On or Off



- a. Press  then  until the display shows one of the following:

sure.v off: None of the PosiVend™ functions are available. Use this if the PosiVend™ system is not installed, or there is some reason you do not want to use it (for example in a high cup theft situation).

sure v. on. The PosiVend™ system is operative. All of the PosiVend™ functions are available.

- b. Press  to switch between the two choices.

Set up Optional or Mandatory PosiVend™



- a. Press  then  until the display shows one of the following:

opt'n sure.v: The machine reverts to home switch operation of the ring motors if the PosiVend™ system cannot operate normally because of an obstruction in the cup station or for any other reason.

must sure.v: The vending machine is operational only if the PosiVend™ system is determined to be working. Otherwise, the machine will go temporarily out of service until the blockage or other error is corrected.



- b. Press  to switch between the two choices.

Set Up the PosiVend™ Anti-Jackpot Timer



- a. Press  then  until the display shows **ajp.tmr xxm**. **XX** represents how many minutes PosiVend™ will be disabled for either cup ring. The same value applies to the two timers (one on each ring).
- b. Enter a number using either keypad.

If any cup ring motor fails to deliver a cup on two consecutive attempts, the cup ring goes out of service. After the time set in step 2 has elapsed, the cup ring goes back in service and is given one more chance to deliver a cup. If cup delivery is again unsuccessful, the ring goes out of service until the machine is serviced. A successful delivery on any cup ring will reset the failed attempts for that particular cup ring. If both cup rings perform three consecutive failed attempts (and the PosiVend™ sensor is determined to be working), the entire machine goes in the “mug only” mode until the machine is serviced. If either cup ring performs three consecutive failed attempts with the other cup ring in anti-jackpot timer mode, the entire machine will be in “mug only” mode (assuming PosiVend™ is working) until the preset time elapses (one more attempt will be made to deliver a cup) or the machine is serviced by a route operator.

View Number of Mug Vends (Not Shown If Zero)





- a. Press  , then press  until the display shows **MUG X**. “X” is the number of mug vends.
- b. If desired, view this data by individual selection.

View Cup Ring Cycles Related to PosiVend™ (Not shown if zero)

- a. Press  , then press  until the display shows **PV.TOT xx**. **XX** represents the number of vends during which more than one ring cycle was required to successfully dispense a cup.
- b. Press  to clear the count.



View Times No Cup Was Detected After a Cup Ring Cycled

(Not shown if zero)



- a. Press , then press  until the display shows **PV.FL1 xx**. **xx** represents the number of times a cup was not detected after ring 1 cycled. Check the cup ring adjustment (see the *Operator's Guide*), or the cup stack for damage if the count is excessive.
- b. Press  to clear the count.
- c. Press  until the display shows **PV.FL2 xx**. **xx** represents the number of times a cup was not detected after ring 2 cycled. Check the cup ring adjustment (see the *Operator's Guide*), or the cup stack for damage if the count is excessive.

View Home Switch Usage Related to PosiVend™



(Not shown if zero)

Press , then press  until the display shows **WO.PV xx**. **xx** represents the number of times home switches were used due to **opt'n posi.v** selected but not working.

View PosiVend™ Last Recorded Calibration Value

Press , insert **-**, then  until the display shows **cal.lst xxx**. **xxx** can be any number from 0 to 255, and represents the most recent value read from the sensor. The lower the number the greater the sensor blockage. A number of 255 means that there is a fatal problem with the PosiVend™ interface board. Ensure the PosiVend™ interface PCB is properly connected to the main controller PCB.

View PosiVend™ Average Calibration Value



Press , then press  until the display shows **cal.ave xxx**. **xxx** represents the average sensor calibration value (should be between 50 and 255 for proper sensor operation - i.e. 51 through 254). Although this number could go as low as 20, the PosiVend™ system will be inoperative in this condition.

Set Prices for Individual Selections

For this procedure, we will assume that the merchandiser is set up to vend two different sizes of cups. Also, the machine is configured to allow customers to vend a cup only (no drink). Here is an example of how to set prices for several different selections in this machine:

HELPFUL HINT

If most of the prices in your machine will be the same, perform the SET ONE PRICE FOR THE ENTIRE MACHINE procedure, then return to this procedure to set those prices which will be different.

- a. Press . The display shows the maximum and minimum prices currently set in the machine.
- b. Either press  to scroll through the selection list until you find the selection number you want.

or

Go directly to the desired selection by pressing its letter.

To help you understand, here is an example. First, set the price for the *regular size C*



selection to \$0.65. Press 0C, or  until...

- c. . . . the display shows **C .55**. (The price for the **C** selection is currently at \$0.55.) Enter the new price (65 cents) using the number keys.



Now, set the price for the *large size D* selection. Press 1D, or  until . . .

- d. . . . the display shows **1 D.75** This is the **D** selection price for the large size cup (the "1" means the large cup).

Set the Price For a Cup Only

- a. Press , then press  until the display shows **2 .XX**. "XX" represents the price for a cup only.
- b. Enter the new price using the number keys.

Set One Price for the Entire Machine



- a. Press . The display shows ** .XX .YY. This is the maximum (XX) and minimum (YY) prices currently set in the machine.
- b. Press . The display shows **.

CAUTION

**Setting all prices in the machine will change the currently set prices.
If you are sure you want to do this, go to the next step.**

- c. Enter a new price.

Set One Price for All Regular Size Drinks



- a. Press . The display shows ** .XX .YY. This is the maximum (XX) and minimum (YY) prices currently set in the machine.
- b. Press 0 (on the selection switch panel) and . The display shows 0*.

CAUTION

**Setting these prices will change the currently set prices.
If you are sure you want to do this, go to the next step.**

- c. Enter a new price.

Set One Price for All Large Size Drinks

- a. Press . The display shows ** .XX .YY. This is the maximum (XX) and minimum (YY) prices currently set in the machine.
- b. Press 1 (on the selection switch panel) and . The display shows 1*.

CAUTION

**Setting these prices will change the currently set prices.
If you are sure you want to do this, go to the next step.**

- c. Enter a new price.

Set the Time



- Press . The display shows **TIME H.MM**. "H.MM" is the time of day currently set in the machine.
- To change the time, just enter the time with the number keys using a 24-hour format (1300 = 1:00 pm).

NOTE

The new time will be displayed, but not updated in the system

until you press an arrow key or .

Set the Day of the Week

- Press , then press  until the display shows @ **SMTWTFS**. The currently set day of the week will be flashing. If it is correct, CONTINUE.
- To change the day, press  until the correct day is flashing.

Set the Date and Year

- Press , and press  until the display shows **MM/DD YY**.



"MM/DD YY" is the month, date, and year currently set in the machine. The slash (/) means that the U.S. date format is being used.

- If desired, enter a new month, date, and year with the number keys.

To change to the European date format (**DD-MM YY**), press . The display is now shown with the date before the month, and the slash (/) is replaced by a dash (-) to avoid confusion.



Set Time-of-Day Inhibited Vending

Vending can be inhibited up to four times a day. This is useful when you don't want the machine used for any reason.

- a. Press , then press  until the display shows **INHIB** - - - - .
- b. Go to the TIME INTERVAL EDITING procedure on page page 75 for an example of how to set up time-of-day inhibited vending.



Set Time-of-Day Discount Vending

Vending can be discounted up to four times a day. For example, this can be used to favor early-arriving employees.

- a. Press , then press  until the display shows **DISCT** - - - - .
- b. Go to the TIME INTERVAL EDITING procedure on page 75 for an example of how to set up Time-of-Day Discount Vending.

Set Time-of-Day Free Vending

Vending can be free up to four times a day.

- a. Press , then press  until the display shows **FREEV** - - - - .
- b. Go to the TIME INTERVAL EDITING procedure on page 75 for an example of how to set up time-of-day free vending.

CUSTOM TIME INTERVALS Times when normal vending is suspended in favor of special cases. For example, coffee could be discounted before working hours in the morning to favor early-arriving employees.

Time Interval Editing

You can select up to four times of day for each special vending period.

NOTE



If two or more of these time periods overlap, the interval with the highest priority will overrule the other(s).

This order of precedence is:

1. INHIBIT
2. FREEVEND
3. DISCOUNT



For example, if a DISCOUNT time period is scheduled before the end of an INHIBIT time period, DISCOUNT does not begin until the INHIBIT interval has ended.



The time interval editing procedure is almost the same for the INHIBIT, FREEVEND, and DISCOUNT intervals. There is one difference for the DISCOUNT time interval, so that interval will be shown here.

- a. The display shows **DISCT 1234** Press the number of the time interval you want to edit, or  to edit time interval 1 (we'll use interval 1 for this example).
- b. The display shows **1.DISCT ON** or **1.DISCT OFF**. This display tells you whether your time interval (represented by X) is on or off. Press  to change the status of the time interval.

NOTE

If you turn an interval ON, it must be edited. You can edit a time interval now, then turn it OFF until later.

- c. Press . The display shows **1.DSCT XX** This is the discount percentage for this period. Enter a discount percentage of 25 with the number keys.
- d. Press . The display shows **1.STRT X.XX** "X.XX" is the currently set start time. Enter a new start time (24-hour format) for this interval. To enter the time for 3:30 pm, enter **1530**.
- e. Press . The display shows **1.STOP X.XX**. "X.XX" is the currently entered stop time. Enter a new stop time (24-hour format) for this interval. To enter a stop time of 6:00 pm, enter **1800**. You have now established a 25% discount that starts at 3:30 pm and ends at 6:00 pm.

- f. Press . The display shows **1.@ - - - - -**. The dashes represent the days that this time interval is active. Pressing number keys 1 through 7 switches the days on/off. The days you select will appear in the display. Press **2, 4, and 6**. The display shows **1.@ - M - W - F -**, meaning that the discount interval is only active on Monday, Wednesday, and Friday.
- g. Press . The display shows **1. - - - - -**. The dashes represent the selections affected by this time interval. Press the appropriate letter key to turn the selections on or off.

NOTE

**Selections not vended by your machine will not be displayed.
Press A, B, F, and H. The display shows 1. A B - - - F - H.**

- h. Press . The display shows either:

1. MESSG OFF There is no custom message selected.

– OR –

1. MESSG X. This means that custom message X (1 through 8) will be displayed during this time interval. Press the number key of the message you want displayed. Pressing **0** turns the message OFF for this time interval.



STAND BY The message that is displayed during normal vending periods when there are no out-of-service faults

(You can also press  to scroll through the message list.)

NOTE

**YOU CAN SET UP THE CUSTOM MESSAGE BY FOLLOWING THE
CUSTOM MESSAGE EDITING PROCEDURE.**



Select a Stand-by Message

- Press , then press  until the display shows **STANDBY MX**. "X" represents the current message number selected for the standby message. Two dashes mean that the factory-set message is selected.
- To select a message, just press the corresponding number (1 through 8). To display the factory-set message, press 0.

– OR –

Press  to scroll through all eight messages and the factory-set message.



Select an Out-of-Service Message

- Press , then press  until the display shows **SERVICE XX**. "XX" represents the current message number selected to display when the machine is out-of-service. Two dashes mean that the factory-set message is selected.
- To select a message, just press the corresponding number (1 through 8). To display the factory-set message, press 0.

– OR –

Press  to scroll through all eight messages and the factory-set message.







Select a FreeVend Message

- Press , then press  until the display shows **FREEVEND XX**. "XX" represents the current message number selected for the message that displays when the machine is in the freevend mode. Two dashes mean that the factory-set message is selected.
- To select a message, just press the corresponding number (1 through 8). To display the factory-set message, press 0.

– OR –

Press  to scroll through all eight messages and the factory-set message.

Edit Custom Messages

- a. Press , and press  until the display shows **EDIT MSG'S**. Press the number of the message you want to edit. **MESSAGE X** is displayed (**X** represents the message number you pressed).
- b. Press . The message text is displayed with the first character flashing.
- c. To view the message, press . The message scrolls across the display. To stop the scrolling, press .
- d. When the character you want to change is flashing, either enter it directly, or use  and  to step through the character set until the desired character is displayed. Use the arrow keys to highlight different characters. See the section on the next page for an explanation of special keys and the character set.

SHORTCUT

Instead of stepping through the whole character set to enter a letter that is not on your keypad, enter one close to the one you want, then step to it. Example: If you want to enter an **L**, first press **J** on the selection switch panel.

- e. Then press  twice. Your L should now be displayed.













The End of Message Character



This is the most important character in your message, because it tells the machine when the message is ended. If you don't use this character, your message will be followed by a bunch of zeros. This character can be selected either from the character set or by a direct key entry (see the next page).

Entering Your Message



You will be using a combination of special keys and the keys on the selection switch panel to enter your message. Pressing the keys on the selection switch panel will enter the character shown on that key. Most of the keys on the service keypad have a special purpose to help you create and edit your messages:

- | | | | |
|--|--|---|--|
|  | Inserts an R at the flashing character. |  | Inserts a space at the flashing character. |
|  | Inserts an S at the flashing character. |  | Deletes the current character and closes up the space. |
|  | Inserts a T at the flashing character. |  | Deletes the current character and leaves the space. |
|  | Repeats the letter to the left of the flashing character. |  | Enters the special "end of message" character, which denotes the end of the message. |
|  | "Pages" through the message, ten characters (one screen) at a time. | | |
|  |  | Steps forward and backward through the message, one character at a time. | |
|  |  | Steps forward and backward through the character list, one character at a time. | |

THE CHARACTER SET

0	A	k	u	[>
1	b	l	v]	?
2	c	m	w	#	@
3	d	n	x	◆	°
4	e	o	y	+	☒
5	f	p	z	-	THIS IS THE END OF MESSAGE CHARACTER.
6	g	q	(Space)	/	
7	h	r	-	.	
8	i	s	\$	<	
9	j	t	'	=	

Test Vend Selections and Verify Credit Added





- a. Press . The display shows **TEST .00**. You may now test vend selections.
- b. To test vend selections without dropping a cup, press . The display shows **TEST.NC .00**. No cups will drop during the rest of your test vend session. If desired, you may place money in the machine.

In either case, if you insert money into the machine, the zeros in the display will be replaced with the amount of the credit.

NOTE

You may make one more test vend if you close the door while still in TEST VEND mode.



Test the Display

- a. Press , then press  until the display shows **DSPLY TEST**.
- b. Press  to light all display segments light; press  to turn them off.
- c. Pressing a number key on the maintenance keypad, or any key on the selection switch panel causes all segments to display that character.



NOTE

To help differentiate the two keypads, a number from the maintenance keypad has an apostrophe after it: 1 '. A number from the selection switch panel has a period after it: 1..



Test the Cup Mechanism

- a. Press , then press  until the display shows **CUP TEST**.
- b. You can test the cup mechanism one of several ways:
- Press **1** or . A cup is dispensed from the cup ring.

Test the Automatic Door (optional)

- a. Press , then press  until the display shows **DOOR TEST**.
- b. Press  to test the automatic delivery door. The door will open, then close after one second.

Test the Whippers



- a. Press , then press  until the display shows **WHIP TEST**.
- b. Press the whipper number (1=5th product mixing bowl, 2=main condiment mixing bowl, 3=not used, 4=H selection, or 5=chocolate) you want to test.

OR



Press the letter of a selection containing a whipper.

In either case, **WHIP X** is displayed while the whipper under test ("X") runs.

Test the Pump

- a. Press , then press  until the display shows **AIR TEST**.
- b. Press  to test the pump.

Test the Brewer



- a. Press , then press  until the display shows **BREW TEST**.
- b. Press  to test each brewer position:

WARNING

**Keep away from the brewer mechanism while it is operating.
Coming into contact with moving parts could injure you.**

- i. **BREW CLMPD** The brewer is in the brew position.
- ii. **BREW HOME** The brewer is in the HOME position.



Test Various Sensors and Switches

- a. Press , then press  until the display shows **IN.XXXXXXX**. The **X**'s in the display will be replaced by the following place holders: **M K P H L 1**, defined as follows:
- M** = mug/cup sensor (if equipped) **K** = freevend keyswitch
P = waste pail switch **H** = high water tank level switch
L = low water tank level switch **1/2** = ring 1/2 cup sensor switch
- b. Actuate each switch or sensor to test its function. As you actuate each input, the display element representing that switch blinks on. Releasing the switch causes that element to blink off again, and be replaced by a dash.

Rinse All Mixing Bowls





WARNING

**Very hot water will be dispensed in this test. Coming into contact
with hot water is dangerous!**





- a. Press , then press  until the display shows **BOWL RINSE**.
- b. Press  to rinse all bowls. **RINSING** is displayed.

View FreeVend Sales by Time Interval

(not shown if zero)





- Press , then press  until the display shows **_0\$ XX.XX**.
- Press , then press  until the display shows **1.FRV .00**. This is the total sales for freevend interval 1, shown even if zero.
- Press  to view intervals 2 through 4.

View Discount Sales by Time Interval

- Press , then press  until the display shows ****\$ XX.XX**.
- Press . The display shows **1.DSC .00**. This is the total sales for discount interval 1 (not shown if zero).
- Press  to view intervals 2 through 4.





View Free Vends

(not shown if zero)



- Press , then press  until the display shows **_0\$ XX.XX**.
- Press , then press  until the display shows **FRV XX.XX**. "XX.XX" is the total machine-wide freevends, shown even if zero.

View Winners

(not shown if zero)

- a. Press , then press  until the display shows **_0\$ XX.XX**.
- b. Press , then press  until the display shows **WIN XX.XX**. "XX.XX" is the total machine-wide winners, shown even if zero.

View Time Data

- a. Press , then press  until the display shows **TIME DATA**.
- b. Press . The following message scrolls across the display: **MAIN.1 237M 01/30 10.13**

This example shows the latest time interval the main (machine) door was open (1). It was open for 237 minutes, and was opened on January 30 (01/30) at 10:13 am (10.13). Press



. If applicable, similar displays will appear for intervals 2, 3, and 4, otherwise, go to the next step.

- c. Press . The following message scrolls across the display:

LAST POWER 01/30 13.51 FOR 00. 0.23

This example shows that the last time the machine lost power was on January 30 (01/30) at 1:51pm (13.51) for zero days, zero hours, and 23 minutes (00. 0.23).

- d. Press . The following message scrolls across the display:

LONGS.T POWER 01/30 10.58 FOR 00. 2.47

This example shows that the longest time the machine was without power was on January 30 (01/30) at 10:58am (10.58) for zero days, 2 hours and 47 minutes (00. 2.47).

- e. Press . The following message scrolls across the display: **FULL CLEAR 01/30 8.58**

This example shows that the last time resettable sales was fully cleared was on January 30 (01/30) at 8:58am (8.58).

- f. Press . The following message scrolls across the display: **TIME SET 01/30 9.15**

This example shows that the last time the time or date was set was on January 30 (01/30) at 9:15 am (9.15).

- g. Press . The following message scrolls across the display: **PRICE SET 01/30 9.42**

This example shows that the last time prices were set was on January 30 (01/30) at 9:42 am (9.42).



NOTE

Refer to (VIEW DATA THREE DIFFERENT WAYS, page 83) to view the date and time of the last vend of that selection.



View Total Unpaid Sales

NOTE



This does not appear if the total of unpaid sales is zero.

- a. Press , then press  until the display shows **_0\$ XX.XX**. "XX.XX" is the total unpaid sales (free vends, winner vends, 100% discounts, zero price vends) for the entire machine.
- b. If desired, view this data by tray and individual selection.

View Total Unpaid Vends





- a. Press , then press  until the display shows **_0 XX**. "XX" is the total number of unpaid vends for the entire machine.
- b. If desired, view this data by tray and individual selection.

View Number of Test Vends (not shown if zero)



- a. Press , then press  until the display shows **TST X**. "X" is the number of test vends.
- b. If desired, view this data by cup size and individual selection.

View Sales Data By Price

You can view the total sales of each separate price in the machine.

- Press , then press  until the display shows **\$ **XX.XX**.
- Press . The display shows the lowest price followed by the dollar sales of all selections costing that price.
- Press  to step through all the prices set in the machine.

View Machine ID Number

- Press , then press  or  until the display shows **I.D. XXXXXX**. The **X**'s represent the 6-digit machine ID number.
- You can edit the machine ID number if the supervisor access code has been previously entered (See "Gain Access to the Supervisor Mode" on page 38).

Set FreeVend Options

- Press  until one of the following is displayed:

FREE OFF - Normal vending mode. No items are on freevend. A closure on the keyswitch input causes the machine to go out of service.

– OR –

FREE ALL - All items are on freevend. The credit display shows **NO MONEY REQUIRED**. A closure on the keyswitch causes the machine to go out of service.

– OR –

FREE W/KEY - All items are freevended while there is a closure on the keyswitch input. Normal cash sales are supported when the keyswitch input is open. If the free vend code (selected under SUPERVISOR MODE) is not 0000, the code must be entered first.





– OR –

FREE ONCE - A closure on the keyswitch input causes only the next item to be freevended. Coin mechanism errors are ignored. This state is designed for card or token systems where one item is vended per token. Normal cash sales are also supported.

- Press  until the option you want is displayed.

FreeVend Keyswitch Option

The free vend keyswitch allows someone to set up free vending without needing to open the door. It is a good idea to establish a free vend code. This will prevent an unauthorized person from setting the machine to free vend, even if they have a key.

- a. Press . Enter your 4-digit supervisor code. Press .
- b. Press  again, then press  until the display shows **FREE XXXX**. Enter a 4-digit free vend code.

NOTE

To keep the user from having to enter a code, you can enter **0000** as your code. See the steps below for details.

- c. Press  until you have left the function.

USING THE FREE VEND KEY SWITCH:

If you have set your freevend option to **FREE W/KEY**:

- a. Place your key in the free vend keyswitch and turn it to the right. (If the keyswitch is already turned to the right, turn it to the left, then back to the right.) The display shows: **ENTER CODE**.

NOTE



If your freevend code is set to **0000**, you will not see this display.
Skip to step 3.

- b. Enter your 4-digit freevend code. If you do this successfully within 6 seconds, you will hear two beeps, and the display shows: **UNLOCKED**.
- c. The display shows **NO MONEY REQUIRED** (or whatever custom message you set up for the freevend period). Remove your key. All vends are free until the keyswitch is turned to the left again.
- d. To take the machine off free vend, insert your key, turn the keyswitch to the left, and remove the key.

If you have set your freevend option to **FREE OFF** or **FREE ALL**:





If the freevend key is turned to the right, the machine will go out of service.

View Non-Resettable Sales and Vend Data



- a. Press . The display shows **NR\$ XX.XX**. "**XX.XX**" is a dollar and cents figure showing the total of all sales in the machine. This is a running total, and is not resettable.
- b. Press . The display shows **NR X**. "**X**" is the total number of vends made by the machine. This is a running total, and is not resettable.

View Data Three Different Ways

Paid sales and vends can be viewed three different ways: By whole machine, by selection type, and by individual selection. The first screen of the data item shows its machine total.



- i. To view the data by selection type, press the letter of the type you want to see. For example, pressing **A** shows you the total sales and vends for the combined regular and large size cups of the A selection. You can then press  and  to see data for all the active selection types.
- ii. To view the data by individual selection, press the letter and number of the selection you want to see. You can then press  and  to see data for all the active selections.
- iii. If viewing data by individual selection, press  to view the date and time of the last vend of that selection.

View Total Paid Sales



- a. Press , then press  until the display shows ****\$ XX.XX**. "**XX.XX**" is a dollar and cents figure showing the total of all PAID sales in the machine (as opposed to unpaid sales like winner and free vends). This is the total since the last time it was cleared.
- b. If desired, view this data by cup size and individual selection.

View Card Reader Paid Sales



(not shown if zero)

- Press , then press  until the display shows **\$ **XX.XX**.
- Press . The display shows **DBT XX.XX**. "**XX.XX**" is the amount of money collected from card reader sales.



View Total Paid Vends

- Press , then press  until the display shows ** **XX**. "**XX**" is the total number of paid vends for the entire machine.
- If desired, view this data by cup size and individual selection.

Clear All Resettable Data

- Press . The display shows **NR\$ XX.XX**. This is a running total, and is not resettable.
- Press and hold . Two beeps sound and the display shows **CLEARING** momentarily, and then changes to **FINISHED**. All data is cleared.

Clear Paid Sales Data Only

- Press , then press  until the display shows **\$ **XX.XX**. "**XX.XX**" is a dollar and cents figure showing the total of all PAID sales in the machine (as opposed to unpaid sales like winner and free vends). This is the total since the last time it was cleared.
- Press and hold . Two beeps sound and the display shows **CLEARING** momentarily, and then changes to **FINISHED**. All paid sales data is cleared; other data is not cleared.

View Amount in Coin Box

(not shown if zero)

- a. Press , then press  until the display shows **CBX XX.XX**.

"**XX.XX**" is the dollar and cents amount in the coin box.

View Amount in Validator

(not shown if zero)

- a. Press , then press  until the display shows **DBV XX.XX**.

"**XX.XX**" is the dollar amount in the bill stacker.

- b. Press  to show the quantities of bills in the stacker. For example, the display shows

\$0120, meaning that there are 20 dollar bills in the bill stacker. Press  again to show the quantities of other bills, such as \$5s, \$10s, or \$20s.

View Diagnostic Messages

- a. Press . The display shows any of the following diagnostic messages, depending upon any fault(s) present:

NO ERRORS

None of the following errors are detected:

KEYPAD xy

Key(s) x, y stuck.

ROM ERROR

Error in the programming EPROM. Machine will not operate.

RAM ERROR

RAM is not initialized or is not compatible with the currently loaded software. If this message appears, initialize your RAM by performing the following procedure:

NOTE:

Initializing RAM will erase all your data and drink settings. Be sure you have written this information down before continuing.

- b. Press and hold  until two beeps are heard, and the display shows **FINISHED**.

DIAGNOSTIC MESSAGES

KEYSWITCH	The keyswitch input is active and configured as an inhibit.
MACH.TYPE 0	Machine type error displays machine type screen. NOTE: This is the actual machine type screen. You may enter the correct machine type number directly on this screen without further action.
D+J+WXYZ	Configuration error; displays the machine configuration screen. NOTE: this is the actual config screen. You may enter the correct config number directly on this screen without further action. (Verify cup size and product times in the product configuration  screen).
TANK ERR	Tank failed to fill or refill.
RING 1, 2	The cup ring is jammed.
MTR 1A1B2X	Cup turrets are jammed.
NO CUPS 1, 2	Out of cups.
BREW JAM	The brewer is jammed.
WASTE PAIL	The waste pail is full.
LOW WATER	The water level in the tank is low.
COLD WATER	Water in the tank is too cold to vend.
NO SENSOR	Temperature sensor failed or missing.
NO FLOAT	Float sensor failed or missing.
WHIP 1 2 3 4 5	Whipper motor failure (motor 1, 2, 3, 4, 5)
DOOR JAM	The automatic delivery door is jammed.
NO MECH	Coin mech not detected - machine will not operate if configured for coin mech
MECH COMM	Incomplete coin mech communications check harness.
MECH.SENSOR	Coin mech reporting a bad tube sensor replace mech.
MECH ROM	Replace the coin mechanism.
MECH.ACCEPT	Coin mechanism acceptor section is unplugged from the main body of the coin mech. Connect the cable and cycle machine power OFF and then ON.
MECH JAM	One or more coin tubes are jammed. Pay a coin from each tube until the jam is cleared.
DEBIT CARD	Card reader reporting error — machine will not operate if configured for DEBIT ONLY.

DIAGNOSTIC MESSAGES

CHECK DBV	Bill validator reporting error — machine will not operate. Empty stacker, clear jams, etc.
DBV COMM	Incomplete bill validator communications — check harness.
DBV MOTOR	One of the motors has failed. The unit will disable itself until the error is corrected. Check for bill stuck in the acceptance path. If no bill is present, replace the validator. Cycle machine power OFF and then ON.
DBV SENSOR	One of the sensors in the bill validator has failed. The unit will disable itself until the error is corrected. Check for bill stuck in the acceptance path. If no bill is present, replace the validator. Cycle machine power OFF and then ON.
DBV JAM	A bill is jammed in the acceptance path. The unit will disable itself until the error is corrected. Remove bill stuck in the acceptance path. Cycle machine power OFF and then ON.
DBV STACKR	The stacker is open or removed. The unit will disable itself until the error is corrected. Install the stacker correctly.
CHK PRICE	Price error detected and changed to maximum - check prices.
NONE READY	All selections are reported out of service.
SV.ERR CUP 1	Cup ring 1 is out of service due to a PosiVend™ error.
SV.ERR CUP 2	Cup ring 2 is out of service due to a PosiVend™ error.
SV.ERR PCB	PosiVend™ is ON but not working. The last calibration sample was 255. Check that the PosiVend™ PCB is present at J34.
SV.ERR SNSR	PosiVend™ is ON but not working. The last calibration sample was 50. Check for a blocked sensor or disconnected harness.
AJP.TMR1 XX	PosiVend™ is active and ring 1 anti-jackpot timer is ON. XX is a value between 1 and 99 in minutes.
JP.TMR2 XX	PosiVend™ is active and ring 2 anti-jackpot timer is ON. XX is a value between 1 and 99 in minutes, and represents the amount of time left on the anti-jackpot timer for this cup ring.
NO BREWER	Brewer is missing or malfunctioning.
BREWER.ERR	The brewer is in an incorrect position.
BREWER JAM	The brewer has not reached an appropriate position within a certain time-out period. Check for a physical jam or a motor stall condition.
RESET BRWR	The brewer is clamped and not vending, or is not in a brewer test mode. Close the door (if open), or run a brew test.



Download Data to a PDCD

- Connect your portable data collection device (PDCD) in accordance with its operating instructions.
- Press . Data is downloaded into your PDCD.

NOTE

Depending upon the setting selected (See “Set Printer or DEX Options” on page 40), data may be cleared after the download is complete.



Change Machine ID Number

- Follow the steps in (See “Gain Access to the Supervisor Mode” on page 38).
- Press , then  until the display shows **I.D. XXXXXX**. The X's represent the 6-digit machine ID number.
- Using the number keys, enter a new ID number.



View the Water Tank Temperature

Press . The display shows **TEMP XX F**. This is the current water tank temperature (in degrees F or C, depending upon your choices).



View the Current Software Version Number

Press , then press  until the display shows **VER XXXX**. This is the current software version number.



View the Selection Machine Type

Press , then  until the display shows **MACH.TYPE (X)**. This is machine type, (See “Set the Machine Type Configuration Code” on page 56).

View the Selection Machine Type Configuration

Press , then press  until the display shows **CONF WXYZ**. This is the machine type configuration. (See "Machine Type Configuration" on page 56) for an explanation of "W", "X", "Y", and "Z".

View the Selection Configuration

- a. Press , then press  until the display shows **0.ABCDEFGH**. This shows which selections are available for sale and setup for regular size drinks. If one or more of the letters in the display are replaced by dashes (-), that selection is unavailable.
- b. Press . The display shows **1.ABCDEFGH**. This shows which selections are available for sale and setup for large size drinks. If one or more of the letters in the display are replaced by dashes (-), that selection is unavailable.

Sanitation

BASICS

INTRODUCTION

Anybody who services vending machines must use proper sanitizing procedures. Health regulations require that hands be clean when cups, commodities, and food-contact parts are handled or serviced.

In addition, Federal and State Health Departments require regular cleaning and sanitizing procedures for food contact parts.

The information in this section will explain how to clean and sanitize the merchandiser on a day to day basis. A clean and well maintained merchandiser will provide a better product and greater safety for your customers.

CLEANING AND SANITIZING -- WHAT'S THE DIFFERENCE?

Clean means "free of visible soil". In cup vending machine servicing, cleaning is also done to maintain product quality and to remove food soils, oils, and mineral stains that could affect product taste, aroma, and appearance.

Sanitizing means the reduction, to safe levels, of the number of disease-causing bacteria that remain on the surface after cleaning. Therefore, cleaning and sanitizing are done in separate steps, as prescribed by health regulations and good industry practice.

When you sanitize you create a healthy and hygienic condition. This leads to wholesome food, which in turn leads to satisfied customers.

SANITIZING IS NO SUBSTITUTE FOR A GOOD CLEANING

HOW DO I SANITIZE?

You can sanitize by using either of these two methods:

Chemicals: The object to be sanitized is treated with a bactericidal compound.

Heat: Raise the temperature of the object high enough to kill bacteria. Water must be at least 170° F.

Hot brew water (if available) is an acceptable sanitizer. When food contact surfaces are washed and/or rinsed, use the hot water available in the machine.

Turn the machine off before using water on the machine.

In either case, the object must be thoroughly clean and completely rinsed in order for the sanitizing process to work. Caked-on soils not removed by cleaning, for example, may shield bacteria from a sanitizing solution.

A GOOD PLACE TO START -- YOUR SANITATION KIT

You need to be sure that each machine is clean, safe, and functioning when you leave it. In order to properly do this, you need to have a complete set of the right tools. In addition to the screwdrivers, pliers, and test equipment necessary to repair a machine, you need to have the tools to clean the machine.

Here is a checklist of the items needed for a good sanitation kit:

- Sanitation pail
- Tube and nozzle brushes for food contact surfaces
- Utility brush for dry spillage around canisters, etc.
- Disposable towels, wet-strength and lint-free

NOTE

Wiping with towels can re-contaminate sanitized food-contact parts. Therefore, towels should not be used to dry food-contact surfaces. Instead, these parts should be air dried.

- Spray detergent, diluted to desired strength
- Urn cleaner packets for coffee stains and oils
- Odor control chemicals for pails
- Replacement parts (if the exchange method is used)
- Cabinet polish or window cleaner for the outside of the machine

Feel free to add some items to this list. For example, you may want to use a portable vacuum cleaner.

SANITATION PROCEDURES

Refer to the recommended cleaning and sanitation interval table on the final page of this section. For each item, complete the procedure as outlined here.

Food-Contact Parts**NOTE**

**All food-contact parts must be cleaned and sanitized.
Air dry, do not wipe dry.**

Ingredient Canisters - Empty and wash the canisters, augers, and spouts. Sanitize with hot water and allow to air dry completely before returning to cabinet.

Mixing Bowls - The inside of all mixing bowls can be rinsed by performing the "Bowl Rinse" operation as outlined in the Programming section of this manual.

If needed, remove mixing bowls from the dry ingredient shelf. Wash the mixing bowl lids and sanitize with hot water. Allow to completely air dry before reassembling.

Whipper Lids and Impellers - Remove lids and impellers from the whipper housings, wash the lids and impeller housing. Sanitize with hot water and allow to air dry before reassembling.

Beverage Discharge Nozzles - Disconnect the beverage dispensing tube from the nozzles. Remove the nozzles from the mounting bracket. Remove the cap from the nozzle, wash

clean and sanitize the nozzles and cap. Refer to the tubing connection diagram for proper routing.

Brewer, Brewer Basket, and Brewer Funnel - The tubing and brewer may be sanitized by performing the BREW RINSE operation as outlined in the programming section. The machine features an automatic brewer sanitizing feature also described in the programming section.

At times, it may be necessary to wash and sanitize the individual brewer parts. If so, disconnect the tubes from the brewer manifold. Remove the brewer barrel and manifold assembly from its support. Remove the brewer basket and funnel assemblies.

Thoroughly wash all parts using soap and water. Sanitize by rinsing thoroughly with hot water.

Coffee Chutes - Remove the metal chute(s), wash clean, and sanitize by rinsing with hot water. Air dry before reinstalling.

Condiment Chute Assembly - Remove the condiment chute and cover from the condiment canisters. Thoroughly wash all parts using soap and water. Sanitize by rinsing thoroughly with hot water.

BREWER CLEANING

The brewer has two main parts you can remove: the brew barrel and the funnel screen and seal assembly. You can remove them with the brewer in the machine, or the entire brewer can be removed as one unit.

- a. On the left side of the brewer, cut off and discard the filter paper (not required for paperless).

- b. Grasp the top of the brew barrel, and turn it counter-clockwise $\frac{1}{4}$ turn to the right as shown. Lift straight up and remove

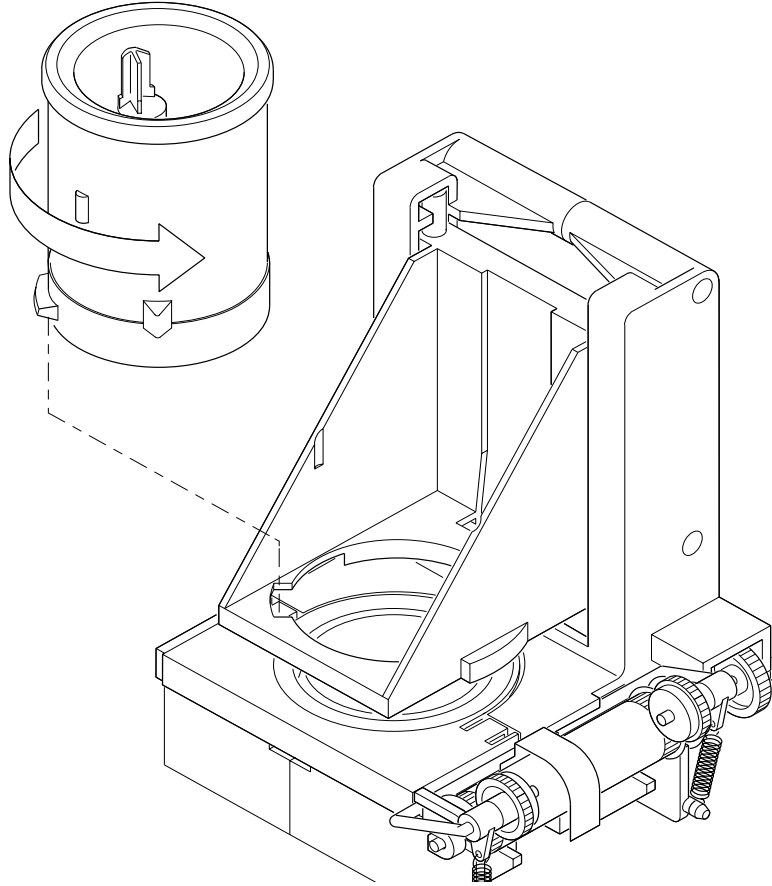

- c. Remove the hose from the bottom of the funnel screen and seal assembly.
- d. At this point, you can remove the brewer or leave it in the machine.
- e. To remove the brewer, tilt the latch down and swivel the brewer up and out.
- f. Remove the screen and seal assembly as shown:
- Press down on the tabs with your fingers, and slide straight back.

LIFT STRAIGHT UP AND PULL OUT.

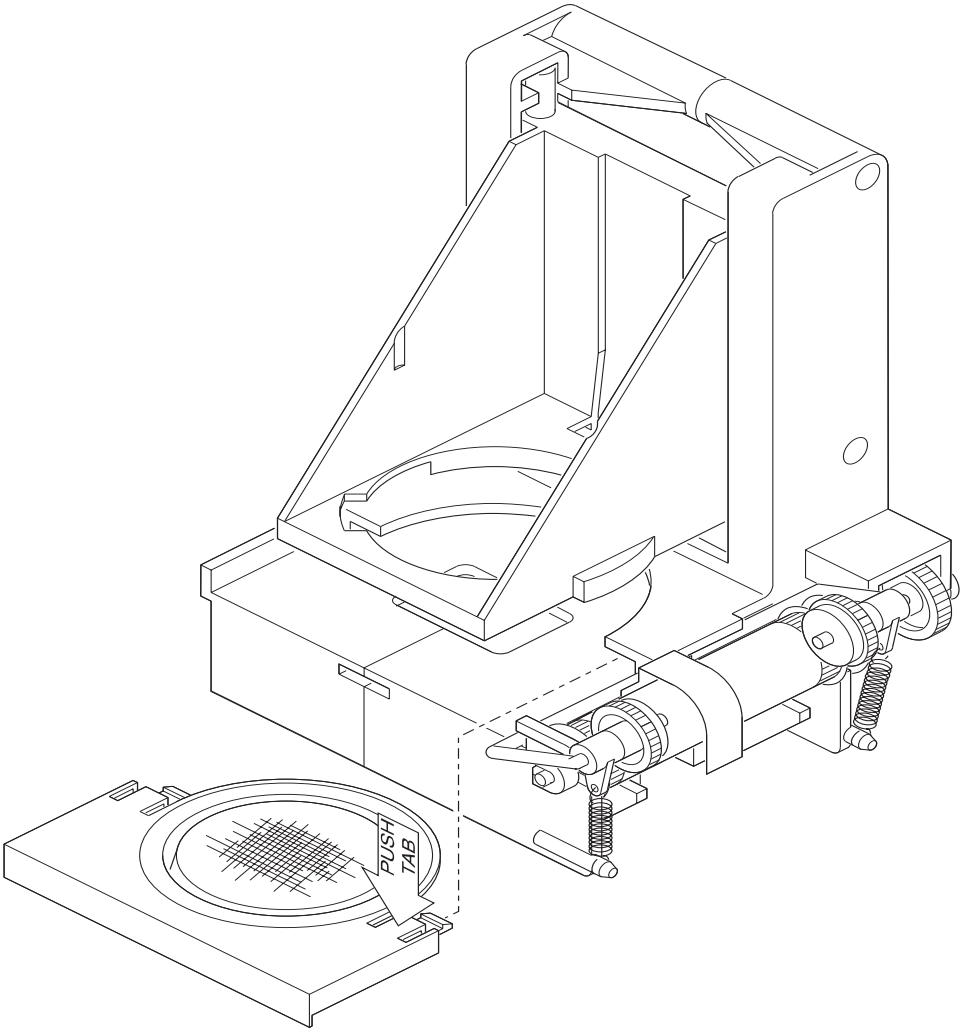

BREWER ASSEMBLY W/ PAPER

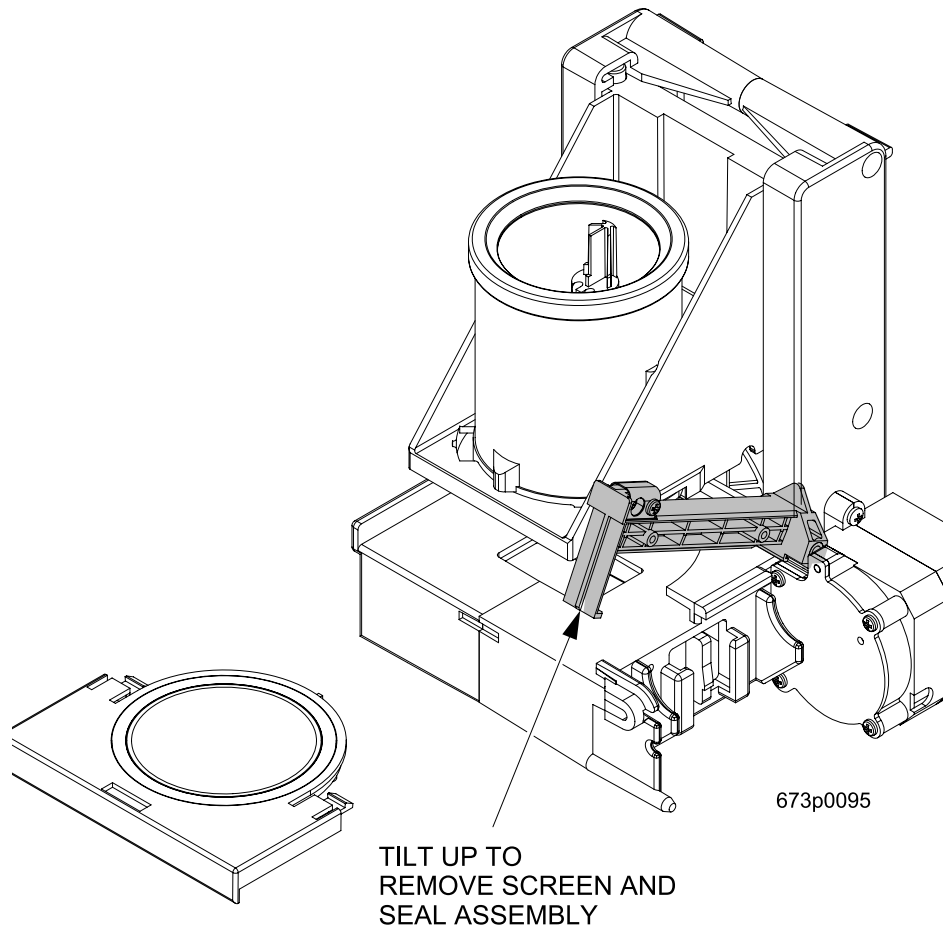

PAPERLESS BREWER ASSEMBLY

- g. Thoroughly wash all parts using soap and water. Sanitize by rinsing thoroughly with hot water. Air dry, or blow dry with compressed air (if available).
- h. If you removed the brewer, make sure the motor drive link is aligned as shown.

- If the motor drive link is aligned properly, the flat on the cam wheel will seat on the bearing.

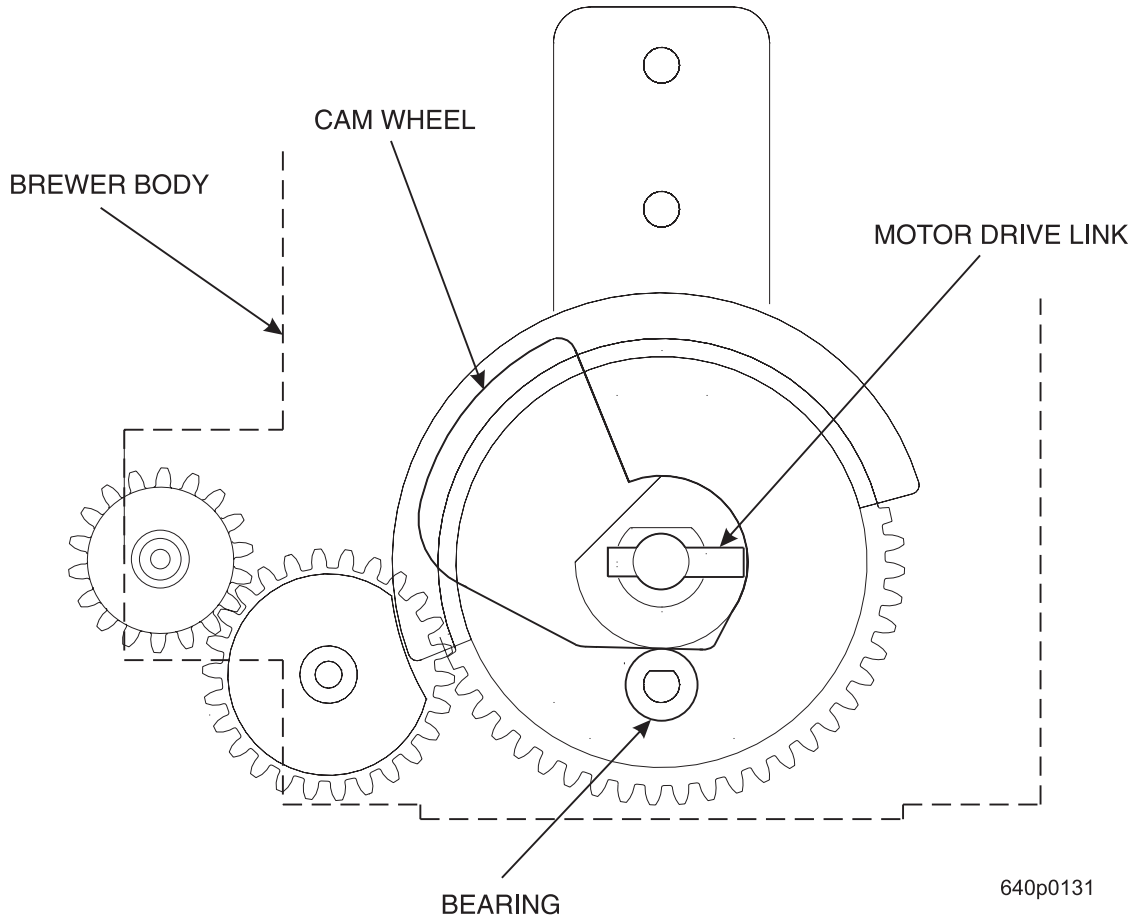

MOTOR DRIVE LINK ALIGNMENT

- If the motor drive link is not aligned properly, the flat on the cam wheel is turned away from the bearing. You must manually turn the cam wheel to capture the bearing on the flat.
 - i. Assemble in the reverse order of disassembly. **NOTE:** when replacing the screen and seal assembly, make sure you hear **TWO CLICKS** as you push it all the way in.
 - j. Feed new filter paper through paper guide and brewer as shown, and don't forget to connect the hose(s)!

k. Position the Squeegee Assembly as shown in the figure below.

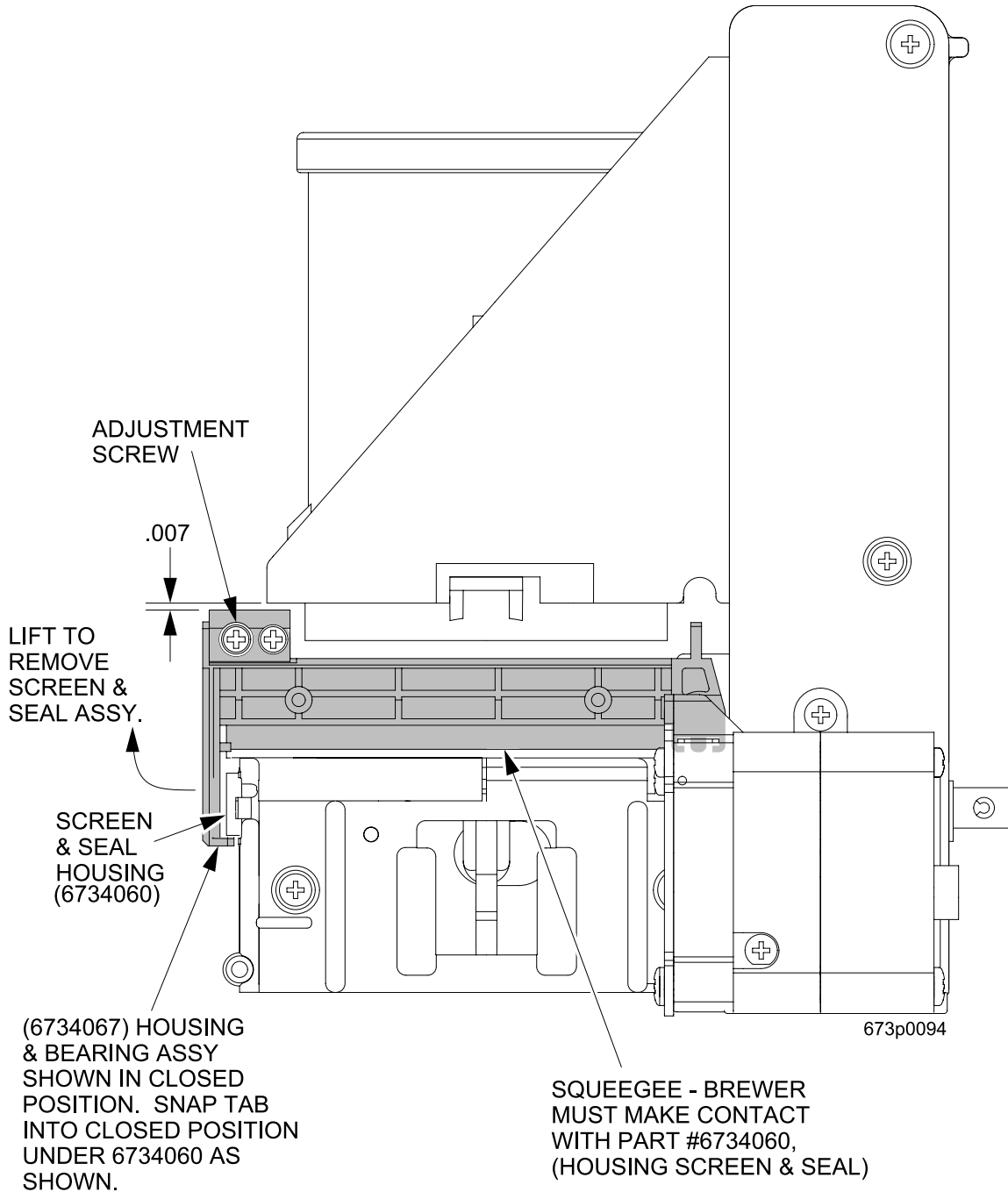

NOTE: THE SQUEEGEE ASSEMBLY MUST BE SEATED CORRECTLY WITH THE PROPER CLEARANCE FROM THE CYLINDER CARRIER (.007") AS SHOWN FOR BEST OPERATION.

Paperless Brewer Assembly

LOAD FILTER PAPER

(See "Load the Optional Filter Paper:" on page 21).

Non Food-Contact Parts

Brewer Mechanism Cleaning - Remove the brewer mechanism from its mounting and rinse with the spray hose.

Cup Delivery Compartment - Remove the compartment from the merchandiser. Wash clean and rinse with hot water.

Exhaust Fan Filter - Remove the filter from its housing. Wash with soap and water, rinse, wring dry, and replace into housing.

Grounds Pail - Empty and rinse the grounds pail. Reline the pail with a clean plastic liner.

Waste Pail - Empty, wash, and rinse with hot water. Sprinkle detergent powder in the bottom of the pail to help control odors.

Ingredient Rinse Tray - Remove product canisters. Wash and rinse with hot water. Allow to air dry.

OVERALL CLEANING

Inspect your merchandiser both inside and out. Be sure to check corners and all less visible parts of the merchandiser.

Clean where needed.

Allow the inside of the cabinet to dry thoroughly before you close the door.

GPL recommends using the following supplies:

A commercial glass cleaner on the glass in the cabinet door.

A mild detergent and warm water on the cabinet, brewer, and other NON ELECTRICAL components.

CAUTION

The plastic parts in your merchandiser should be cleaned with mild detergent and warm water. The use of other cleaning agents may damage the material, and should be avoided.

PREVENTATIVE MAINTENANCE CLEANING

Periodically, you should visually inspect your merchandiser's hot water tank for excessive lime and scale buildup. This buildup on the tank walls, water valves, and heater element will vary dramatically, depending upon water quality. You should develop a cleaning and deliming schedule based on the apparent local water quality.

NOTE

To aid in removing scale from your merchandiser, GPL has a service kit available: part number 6400080. In addition, if your machine has the Everpure water inlet filter system option, a second kit (part number 6400086) is also available.

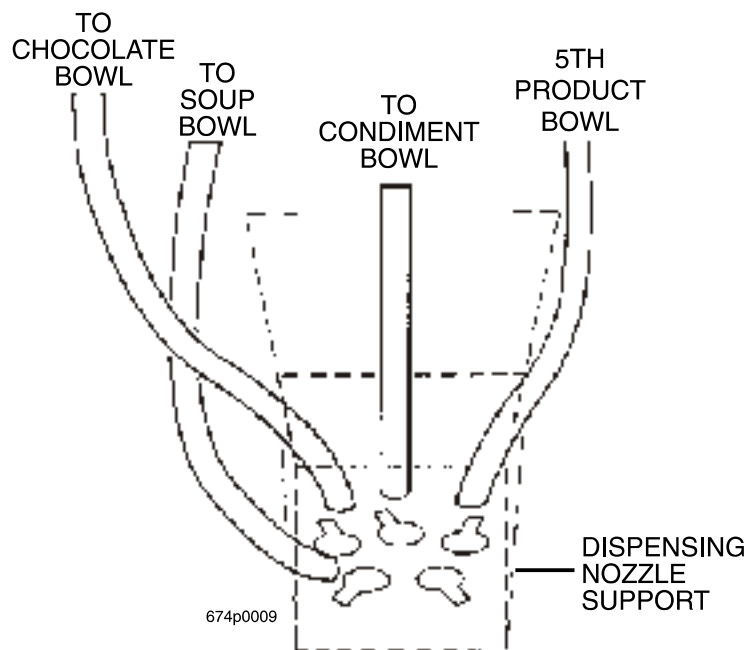
**CLEANING HOT WATER TANK**

Some smell and/or taste problems may occur in new machines. Follow this procedure to clean the hot water tank if you experience problems:

- a. If the machine is in service, remove power from the machine.
- b. Dissolve 1 tablespoon of common baking soda in a cup of water.

WARNING

The water tank may be HOT. Be careful when working on the tank.

- c. Loosen or remove the hot water tank lid and pour the baking soda solution into the tank.
- d. Apply power to the machine.
- e. If the tank is not full, fill it.
- f. Allow the tank to reach its operating temperature.
- g. Leave the solution in the tank for **AT LEAST** ½ hour. If possible, leave the solution in the tank for 1 hour.
- h. Drain the tank.
- i. Refill the tank, then drain again.
- j. Refill the tank and put the machine back into service.

Alphabetical Index

A	C
Acceptor, bill (optional) 12	Cabinet, merchandiser, interior
Access, data clearing, lock or unlock 43	Figure 1 of 2 5
Accessories, and options	Figure 2 of 2 6
Unique to 115V machines, table 2	Caffe latte, recipe 63
Unique to 220-240V machines, table 2	Calibration value, PosiVend™
Adjustments, and minor maintenance 30	Average, view 70
Anti-jackpot timer, PosiVend™, set up 69	Last recorded, view 70
	Canister mapping
B	Figure 56
Balance, declining 46	Table 57
Base plate, mounting 17	Canister, modify to vend
Baud rate, printer, set 40	12 oz. cups (optional) 31
Bill	Canisters
Stacker, emptying 30	Filling 26
Validator, and options, select 45	Installing 31
Validator, nonstandard, initial setup 46	Cappucino, recipe 62
Acceptor (optional) 12	Card reader
Bowl rinse time, set 55	Paid sales, view 89
Bowls, mixing, rinse all 82	And options, select 47
Box	Character
Coin, view amount in 90	Set, figure 79
Lock, coin, optional, installing 23	End of message 78
Breakers, circuit 7	Chemical sanitation 95
Brew	Circuit breakers 7
Rinse time interval, set up 55	Cleaning
Single, definition 57	And sanitizing, difference between 95
Dual, definition 57	Brewer 97
Brewer assembly	Overall 103
Paperless, figure 100, 102	Preventive maintenance 104
With paper, figure 99	Code
Brewer	Configuration, machine type, set 56
Cleaning 97	FreeVend, enter 39
Configuration, table 57	Coin mechanism
Rinse 67	And options, select 44
Test 82	MDB 24
Button, coin return 12	Set up and load 23

C (cont'd)

Coin	
Box, view amount in	90
Return, button	12
Lock box, optional, installing	23
Coins, payout	48
Condiment throws, collecting, figure	59
Configuration	
Code, machine type, set	56
Machine type, table	56
Selection machine type, view	94
Selection, view	94
Connecting, everything	15
Control panel switches, explanation	36
Control panel, power	
(UK/Mexico), figure	9
(US/Canada), back side, figure	8
(US/Canada), front side, figure	8
Control panel, US/Canada, back side of	7
Controller, main, display, figure	10
Controls and indicators	7
CUNO	18
Cup mechanism	
Adjusting	32
Test	80
Cup ring cycles	
Related to PosiVend™, view	69
View times no cup was detected after	70
Cup sizes, assign to selections	50
Cup, only, set price for	71
Cups	
Loading	27
Sizes	27
Custom messages, edit	78

D

Data	
Clearing access, lock or unlock	43
Download to a PDCD	93
Paid sales only, clear	89
Resettable, clear all	89
Sales and vend, non-resettable, view	88

D (cont'd)

Data (cont'd)	
Sales, view by price	86
Time, view	84
View three different ways	88
Date and year, set	73
Day of the week, set	73
Declining balance	46
DEX, or printer options, set	40
DEX/UCS interface, operation	42
Diagnostic messages	
Table	91
View	90
Discount	
Sales, view by time interval	83
Vending, time-of-day, set	74
Mug, set up	49
Dispensing, low temperature, set up	53
Display	35
Language, select	43
Main controller, figure	10
Message	12
Test	80
Door	
Switch, low voltage	12
Automatic, test	81
Drink, hot, set up	51
Drinks	
Large size, set one price for	72
Regular size, set one price for	72
Drive link, motor, alignment, figure	101
Dry product	
Gram throws, collecting	59
Weight factory default settings, table	60
Dual brew, definition	57

E

Electrical power	
Supply connecting merchandiser to	15
Requirements	13
End of message character	78
Errors, tank, clear and fill the tank	56

F	K
5th product, configuration, table57	Keypad, service 12, 34
Filter paper, optional, loading 21	Figure 12
Filter, water	Keys
Cuno brand, installing 18	Function 35
Everpure brand, installing 19	Mode, lock or unlock 39
Hydrolife brand, installing 20	Other 36
Final preparation, mechanical 16	Payout, lock or unlock 39
Free vend, keyswitch 12	Keyswitch
Free vending, time-of-day, set 74	Free vend 12
Free vends, view 83	FreeVend, option 87
FreeVend	Kit
Code, enter 39	Sanitation 96
Keyswitch, option 87	Service, scale removing 104
Message, select 77	
Options, set 86	L
Sales, view by time interval 83	Language, display, select 43
Front of merchandiser, figure 3	Latte, cafe, recipe 63
Function keys 35	LED 1, power on 10
H	LED 2, heartbeat 10
Heartbeat, LED 2 10	Leveling, merchandiser 16
Heat sanitation 95	Line, supply, water 14
Home switch, view usage	Link, motor drive, alignment, figure 101
related to PosiVend™ 70	Location, preparation 13
Hot drink, set up 51	Lock box, coin, optional, installing 23
Hot water tank	Low power settings, set up 54
Temperature, view or set 53	Low temperature dispensing, set up 53
Cleaning 104	
HotCup, programming 34	M
I	Machine ID number
ID number, machine	Change 93
Change 93	View 86
View 86	Machine type configuration
Indicators, and controls 7	Code, set 56
Ingredient throws, collecting, figure 59	Selection, view 94
Inhibited vending, time-of-day, set 74	Table 56
Interface, DEX/UCS, operation 42	Machine
Interior view, of merchandiser, figure 4	Specifications, common to all, table 1
Interlock switch, high voltage	Type, selection, view 93
(International) 12	Entire, set one price for 72
(US/Canada) 12	Test 28
Interval, time, editing 75	

M (cont'd)	M (cont'd)
Machines, 115V	Messages
Options and accessories, table 2	Custom, edit 78
Specifications, table 2	Diagnostic, table 91
Machines, 220-240V	Diagnostic, view 90
Options and accessories, table 2	Mixing bowls, rinse all 82
Specifications, table 2	Mode keys, lock or unlock 39
Main controller, display, figure 10	Mode, supervisor 38
Main power switch 7	Enter new 39
Maintenance	Gain access to 38
Minor, and adjustments 30	Mode, winner, set up 48
Preventive, cleaning 104	Monetary
Major parts 3	Options, select 46
Mapping, canister	Panel, figure 11
Figure 56	Motor drive link alignment, figure 101
Table 57	Mug
MDB coin mechanism 24	Discount, set up 49
Mechanical, final preparation 16	Vends, view number of 69
Mechanism, coin	N
And options, select 44	No cup detected, after a cup
MDB 24	ring cycle, view times 70
Set up and load 23	Noise potential, check 13
Mechanism, cup	O
Adjusting 32	Optional printer, set up 41
Test 80	Options, and accessories
Menu assembly, set up 33	Unique to 115V machines, table 2
Merchandiser, cabinet interior	Unique to 220-240V machines, table 2
Figure 1 of 2 5	Options
Figure 2 of 2 6	FreeVend, set 86
Merchandiser	Product, table 1
Connecting, to electrical	Outlet, power, check 13
power supply 15	Out-of-service message, select 77
Connecting, to water supply 15	P
Front of, figure 3	Paid sales
Interior view, figure 4	Data only, clear 89
Leveling 16	Card reader, view 89
Positioning 14	Total, view 88
Message	Paid vends, total, view 89
Display 12	
End of, character 78	
Entering 79	
FreeVend, select 77	
Out-of-service, select 77	
Stand-by, select 77	

P (cont'd)	P (cont'd)
Panel, control	Power, control panel
Switches, explanation 36	(UK/Mexico), figure 9
US/Canada, back side of 7	(US/Canada), back side, figure 8
Panel	(US/Canada), front side, figure 8
Monetary, figure 11	Preparation
Power 7	Location 13
Selection switch 12, 34	Mechanical, final 16
Paper	Pressure, water, at location 14
Brewer with, assembly, figure 99	Preventive maintenance cleaning 104
Filter, optional, loading 21	Price, set
Paperless brewer assembly, figure 100, 102	For cup only 71
Parts	One for all large size drinks 72
Food-contact, sanitation of 96	One for all regular size drinks 72
Major 3	One for entire machine 72
Non food-contact, sanitation of 103	Prices, set for individual selections 71
Payout	Printer
Coins 48	Baud rate, set 40
Keys, lock or unlock 39	Or DEX options, set 40
PDCD, download data to 93	Optional, set up 41
Polarity, check 13	Procedures, programming 38
Positioning, merchandiser 14	Some conventions 38
PosiVend™ 29	Procedures, sanitation 96
Anti-jackpot timer, set up 69	Product
Average calibration value, view 70	Options, table 1
Last recorded calibration	Weight, dry, factory default
value, view 70	settings, table 60
Optional or mandatory, set up 68	5th, configuration, table 57
Turn on or off 68	Dry, gram throws, collecting 59
View cup ring cycles related to 69	Programming
View home switch usgae rlated to 70	Procedures 38
Power	Procedures, some conventions 38
On, LED1 10	Getting around 34
Outlet, check 13	HotCup 34
Panel 7	Pump, test 81
Power requirements	
Electrical 13	Q
Figure 13	Quarter switch, setting 23
Power settings, low, set up 54	
Power supply, electrical,	
connecting merchandiser to 15	
Power switch, main 7	

R

Reader, card, and options, select 47

Requirements

- Power, electrical 13
- Power, figure 13
- Water 14

Resettable data, clear all 89

Rinse time

- Interval, brewer, set up 55
- Bowl, set 55

S

Sales

- And vend data, non-resettable, view 88
- Data, paid only, clear 89
- Data, view by price 86
- Card reader paid, view 89
- Discount, view by time interval 83
- FreeVend, view by time interval 83
- Total paid, view 88
- Unpaid, view total 85

Sanitation

- Basics 95
- Kit 96
- Of food-contact parts 96
- Of non food-contact parts 103
- Procedures 96
- Section 95
- Chemical 95
- Heat 95
- Introduction 95
- And cleaning, difference between 95

Sanitizing, how to 95

Scale removing, service kit 104

Selection

- Configuration, view 94
- Switch, panel 12, 34
- Machine type configuration, view 94
- Machine type, view 93

S

Selections

- Assign cup sizes to 50
- Disabling in the merchandiser 66
- Individual, set prices for 71
- Lock or unlock 66
- Test vend and verify credit added 80

Sensors and switches, various, test 82

Service keypad 12, 34

- Figure 12

Service kit, scale removing 104

Single brew, definition 57

Size

- Large, drinks, set one price for 72
- Regular, drinks, set one price for 72

Sizes, cups 27

Software version number, current, view 93

Specifications

- Common to all machines, table 1
- Unique to 115V machines, table 2
- Unique to 220-240V machines, table 2

Stacker, bill, emptying 30

Stand-by message, select 77

Supervisor mode 38

- Enter new 39
- Gain access to 38

Supply line, water 14

Switch

- Home, view usage
related to PosiVend 70
- Interlock, high voltage (International) 12
- Interlock, high voltage (US Canada) 12
- Low voltage, door 12
- Power, main 7
- Quarter, setting 23
- Selection, panel 12, 34

Switches

- And sensors, various, test 82
- Control panel, explanation 36

T	V (cont'd)
Tank	Vend
Errors, clear and fill the tank 56	Data, and sales, non-resettable, view 88
Fill 67	Free, keyswitch 12
Filling 26	Test, selections and
Hot water, cleaning 104	verify credit added 80
Hot water, temperature, view or set 53	Vending, time-of-day
Water, temperature, view 93	Discount, set 74
Temperature	Free, set 74
Hot water tank, view or set 53	Inhibited, set 74
Water tank, view 93	Vends
Test	Free, view 83
Vends, view number 85	Mug, view number of 69
Vend selections and	Test, view number 85
verify credit added 80	Total paid, view 89
Throw time, factory default settings	Unpaid, view total 85
collecting, table 60	Version number, current software, view 93
Throw, water,	Voltage, check 13
default times and volumes, table 65	
Throws, water, collecting 63	W
Time	Water filter
Data, view 84	Cuno brand, installing 18
Interval editing 75	Everpure brand, installing 19
Set 73	Hydrolife brand, installing 20
Time-of-day	Water
Discount vending, set 74	Pressure, at location 14
Free vending, set 74	Supply, connecting merchandiser to 15
Inhibited vending, set 74	Supply, line 14
Total paid	Tank temperature, view 93
Sales, view 88	Tank, hot, temperature, view or set 53
Vends, view 89	Throw, default times
U	and volumes, table 65
UCS/DEX interface, operation 42	Throws, collecting 63
Unpaid	Valves, adjusting 30
Sales, view total 85	Hot, tank, cleaning 104
Vends, view total 85	Requirements 14
V	Whipper, options 52
Validator	Whippers, test 81
Bill, and options, select 45	Winner 48
Bill, nonstandard, initial setup 46	Mode, set up 48
View amount in 90	Winners, view 84
Valves, water, adjusting 30	Y
	Year, and date, set 73

